

# CATALOGUE 2023

**KETER**<sup>®</sup>



**We design with people in mind.**



# Stylish house



01.  
Storage  
p. 8



02.  
Waste  
p. 42



03.  
Kitchen  
p. 58



04.  
Laundry  
p. 94



05.  
Cleaning  
p. 104



06.  
Pets  
p. 112



07.  
Camping  
p. 120



08.  
DIY  
p. 124



# Garden life



09.  
Chairs  
p. 146



10.  
Tables  
p. 160



11.  
B&L sets  
p. 174



12.  
Sun  
loungers  
p. 230



# Garden style



13.  
Garden  
sheds  
p. 238



14.  
Storage  
boxes  
p. 264



15.  
Carts  
p. 282



16.  
Outdoor  
bins  
p. 286



17.  
Garden  
toys  
p. 290



18.  
Planters  
p. 294



19.  
Composters  
p. 308



20.  
Garden  
accessories  
p. 312





# Everyday Sustainability

Zrównoważony rozwój każdego dnia • Устойчивое развитие каждый день • Fenntartható fejlődés minden nap

We want to help build a world in which acting for the environment becomes an easy part of daily life. That's why we're creating products that are truly sustainable: they help reduce pollution, whilst being super-functional, affordable, and most importantly: they genuinely bring good into our lives, everyday.

Chcemy pomóc kształtować świat, w którym troska o środowisko staje się częścią naszego codziennego życia. Dlatego tworzymy w pełni zrównoważone produkty, które umożliwiają ograniczanie zanieczyszczenia środowiska, a jednocześnie są funkcjonalne, dostępne i – co najważniejsze – każdego dnia wnoszą coś dobrego do naszej codzienności.

Мы хотим помочь строить мир, в котором забота об окружающей среде становится нашей повседневностью. Поэтому мы создаем продукцию, которая действительно отвечает целям устойчивого развития: она помогает снизить загрязненность и, в то же время, является очень функциональной, доступной по цене, и самое главное: они действительно приносят добро в нашу жизнь каждый день.

Szeretnénk segíteni egy olyan világ megteremtésében, ahol a környezetért való cselekvés mindennapjaink részévé válik. Ezért olyan termékeket hozunk létre, amelyek valóban fenntarthatóak: segítenek csökkenteni a környezetszennyezést, miközben rendkívül funkcionálisak, megfizethetőek, és ami a legfontosabb: valóban jót hoznak az életünkbe minden nap.

# Our Sustainability Framework

Cele zrównoważonego rozwoju • Наши принципы устойчивого развития • Fenntarthatósági elveink



## Better products for better places

Lepsze produkty dla naszego otoczenia • Лучшая продукция – это лучшие места • A jobb termékek a jobb helyekhez

Deliver innovative and affordable lifestyle solutions for different people and places and advance a circular economy through use of recycled content and recyclable design.

Dostarczanie innowacyjnych i dostępnych w codziennym życiu rozwiązań, dopasowanych dla różnych odbiorców i otoczenia. Popularyzacja gospodarki w obiegu zamkniętym poprzez wykorzystanie materiałów pochodzących z recyklingu oraz tworzenie nowych produktów nadających się do ponownego odzysku.

Предоставление инновационных и доступных по цене решений, касающихся стиля жизни, предназначенных для разных людей и мест, а также развитие экономики замкнутого цикла благодаря использованию переработанных материалов и пригодной к переработке продукции.

Innovatív és megfizethető életstílus-megoldások nyújtása különböző emberek és helyek számára, valamint a gazdaság előmozdítása az újrahasznosított anyagok és újrahasznosítható termékek felhasználásával.



## Better planet

Lepsza planeta • Лучшая планета • Egy jobb bolygó

Mitigate climate change risk through operational efficiencies and environmentally positive actions throughout our supply chain.

Ograniczanie ryzyka zmian klimatycznych poprzez efektywną wydajność operacyjną i przyjazne dla środowiska działania w naszym łańcuchu dostaw.

Ograniczenie угрозы изменения климата путем повышения операционной производительности и деятельность, благоприятная для окружающей среды, во всей нашей цепочке поставок.

Az éghajlatváltozás kockázatának csökkentése a működési hatékonyság növelésével és környezetbarát intézkedésekkel a teljes ellátási láncunkban.

## Better business

Lepszy biznes • Лучший бизнес • Egy jobb üzlet

Deliver business, and social value through ethical conduct, diversity, employee wellbeing and engagement and community involvement.

Prowadzenie działalności gospodarczej oraz dostarczanie wartości biznesowych i społecznych poprzez etyczne działania, różnorodność, dbałość o dobre samopoczucie pracowników oraz zaangażowanie społeczne.

Обеспечение деловых и социальных ценностей посредством этического поведения, разнообразия, хорошего самочувствия и вовлеченности работников, а также участие в общественной деятельности.

Üzleti és társadalmi értékteremtés az etikus magatartás, a sokszínűség, a munkavállalók jóléte és elkötelezettsége, valamint a közösségi együttműködés révén.



# The Keter Everyday Sustainability 2025 Pledge

Zobowiązania Keter w ramach programu „Zrównoważony rozwój każdego dnia do 2025 roku” • Декларация Keter Устойчивое развитие каждый день 2025 • Keter nyilatkozat: Fenntartható fejlődés a mindennapokban 2025-re



- 1. 55% of recycled content in total production** • Osiągnięcie całkowitego udziału materiałów z recyklingu w produkcji na poziomie powyżej 55%
  - 55% содержания вторичного сырья в общем объеме производства
  - 55%-ban újrahasznosított anyagok a teljes termelésben •
- 2. Continued zero production of single-use plastic consumer products** • Kontynuacja polityki tworzenia produktów wielokrotnego użytku • Продолжение нулевого уровня производства одноразовых продуктов повседневного пользования из пластика • A műanyagból készült egyszer használatos termékek gyártásának mellőzése továbbra is •
- 3. Product end-of-life programs implemented in all regions** • Wdrożenie programów mających na celu zagospodarowanie zużytych przez konsumentów produktów • Программы изъятия продукта из эксплуатации, реализуемые во всех регионах • Az életciklus végén lévő termékekkel kapcsolatos programok végrehajtása minden régióban •
- 4. 30% of sales from innovation** • Uzyskanie 30% wartości sprzedaży pochodzącej z wdrożenia innowacyjnych rozwiązań • 30% продаж от инноваций • Az értékesítés 30%-a az innovációkból származik •
- 5. 25% reduction in greenhouse gas emissions from production** • Zmniejszenie emisji gazów cieplarnianych podczas procesów produkcyjnych o 25% • Снижение производственных выбросов парниковых газов на 25% • A gyártás során keletkező üvegházhatású gázok kibocsátásának 25%-os csökkentése •
- 6. Zero waste to landfill from production** • Eliminacja odpadów produkcyjnych wywożonych na wysypiska „zero waste” • Ноль производственных отходов, попадающих на свалки • A termelésből a szemételepre kerülő hulladék nullára csökkentése •
- 7. 35% women in management and leadership roles** • Zagwarantowanie 35% stanowisk kierowniczych dla kobiet • 35% женщин на руководящих должностях • 35% a nők aránya a vezetői pozíciókban •
- 8. 90% employee participation in a wellbeing program** • Zaangażowanie 90% naszych pracowników w program dbałości o dobre samopoczucie w miejscu pracy • 90% работников, вовлеченных в программу Состояние здоровья и самочувствие • A munkavállalók 90%-a részt vesz jóléti programokban •

# Sustainability Highlights

Zrównoważony rozwój – kluczowe działania • Ключевые аспекты устойчивого развития • A fenntartó fejlődés kulcspontjai



## 40% of our production used recycled content (up from 38% in 2019)

• W 40% naszych produktów wykorzystano materiały pochodzące z recyklingu (wzrost z 38% od 2019 r.) • 40% нашей продукции используют переработанные материалы (выше 38% в 2019 г.) • Gyártás során 40%-ban újrahasznosított anyagok felhasználása (38%-os növekedés 2019 óta) •



## 160,000 tons of recycled resin used, representing 40% of total production

• 160 000 ton zużytego przez nas tworzywa pochodziło z recyklingu i stanowi to 40% naszej całkowitej produkcji • 160.000 тонн используемой смолы получены после переработки, что составляет 40% общего объема производства • 160.000 tonna újrahasznosított műanyag, ami a teljes termelés 40%-át teszi ki •



## 26% reduction in waste to landfill

• O 26% zredukowaliśmy ilość odpadów trafiających na wysypisko • Количество отходов, попадающих на свалки, уменьшено на 26% • A hulladéklerakókba kerülő hulladék mennyiségének 26%-os csökkentése •



## 29% of sales were generated from innovation

• 29% naszej sprzedaży wygenerowane zostało poprzez wprowadzenie innowacyjnych produktów i rozwiązań • 29% продаж от инноваций • 29%-os innovációból származó értékesítés •



## 99.9% of our consumer products were 100% recyclable

• 99,9% naszych produktów w 100% nadawało się do recyklingu • 99,9% нашей потребительской продукции полностью подлежало переработке • Fogyasztói termékeink 99,9%-a teljes mértékben újrahasznosítható •



## 35% of our manager roles were held by women

• W naszej firmie 35% stanowisk kierowniczych objętych jest przez kobiety • 35% руководящих должностей в нашей компании занимают женщины • A vállalatunk vezetői pozícióit 35%-ban nők töltik be •



## 170,000 tons CO2e emissions avoided by using recycled PP instead of PP

• Dzięki zastosowaniu polipropylenu z recyklingu zamiast czystego PP zapobiegliśmy emisji 170 000 ton CO<sub>2</sub> • 170.000 тонн газа CO<sub>2</sub> не было выброшено в окружающую среду благодаря применению полипропилена (PP) из переработки вместо PP • 170.000 tonna CO<sub>2</sub> nem került kibocsátásra az újrahasznosított polipropilén (PP) használatának köszönhetően PP helyett •







Welcome  
home

# Stylish house

A perfect match of functionality and style, Curver combines the classical with the modern allowing you to create a beautiful and organised space for you and your loved ones: an interior to inspire.

Idealne połączenie stylu i funkcjonalności, klasyki z nowoczesnością – tym właśnie są produkty Curver. Dzięki nim wykreujesz piękną oraz uporządkowaną przestrzeń dla siebie i swoich najbliższych. Stworzysz wnętrze, które będzie inspirować.

Продукция Curver – это гармоничное сочетание стиля и функциональности, классики и современности. С ней легко организовывать красивое и удобное пространство для себя и своих близких. Можно создать интерьер, который будет вдохновлять.

Stílus és funkcionalitás, klasszikus és modern stílus tökéletes kombinációja – ez a Curver termékek lényege. Segítségükkel saját magadnak és szeretteidnek gyönyörű, rendezett környezetet teremthetsz. A belső tereket inspirálóvá varázsolhatod.



**01.  
Storage**  
p. 8



**02.  
Waste**  
p. 42

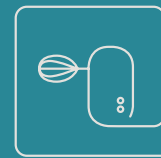

**03.  
Kitchen**  
p. 58



**04.  
Laundry**  
p. 94



**05.  
Cleaning**  
p. 104



**06.  
Pets**  
p. 112



**07.  
Camping**  
p. 120



**08.  
DIY**  
p. 124

**CURVER**



# 01

## STORAGE

Przechowywanie | Хранение | Tárolás



Welcome home





# Jute BASKET



1. BASKET ROUND + LID ~2 L 01903

ø170 × H130 mm | 5



2. BASKET CUBE ~17 L 01906

280 × 280 × H270 mm | 4



3. BASKET S ~5 L 01904

270 × 200 × H110 mm | 6



4. BASKET M ~12 L 01905

360 × 280 × H150 mm | 6



5. BASKET L ~20 L 01907

360 × 280 × H230 mm | 6







**1. BASKET XS ~3.5 L 00700**

175 × 235 × H120 mm | 5



**2. BASKET S ~6 L 00701**

266 × 220 × H150 mm | 5



**3. BASKET M ~12 L 00702**

380 × 285 × H150 mm | 5



**4. BASKET L ~18 L 00703**

380 × 280 × H220 mm | 5



**5. BASKET XL ~30 L 00704**

440 × 330 × H270 mm | 5



# Filo BASKET



1



4



2



5



3





# Style BASKET



**1. BASKET S + LID ~6 L 03617**  
291 × 198 × H142 mm | 3



**2. BASKET M + LID ~18 L 03618**  
393 × 293 × H187 mm | 3



**3. BASKET L + LID ~30 L 03619**  
445 × 330 × H248 mm | 3



**4. BASKET S ~6 L 03614**  
285 × 194 × H130 mm | 3



**5. BASKET M ~18 L 03615**  
386 × 287 × H170 mm | 3



**6. BASKET L ~30 L 03616**  
436 × 326 × H230 mm | 3



1



2



3



4



5



6



7



8



9



10

**CURVER**

# Style TRUNKS & DRAWERS

**7. TRUNK ~43 L 00711**  
500 × 400 × H330 mm | 4



**8. TRUNK ~72 L 00712**  
790 × 400 × H330 mm | 4



**9. DRAWER 4 × ~14 L 06605**  
330 × 380 × H790 mm | 1



**10. DRAWER 3 × ~14 L 06604**  
330 × 380 × H595 mm | 1





# Infinity RECYCLED



**1. BOX DOTS ~1.4 L** 02036

167 × 125 × H83 mm | 6



**2. BOX DOTS ~4.5 L** 04747

260 × 180 × H120 mm | 5



**3. BOX DOTS ~11 L** 04750

360 × 270 × H140 mm | 6



**4. BOX DOTS ~17 L** 04740

360 × 270 × H220 mm | 5



5



6



7

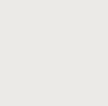

# Infinity DOTS WITH LID



**5. BOX DOTS + LID ~4.5 L** 04760

270 × 190 × H120 mm | 5



**6. BOX DOTS + LID ~11 L** 04753

360 × 270 × H140 mm | 5



**7. BOX DOTS + LID ~17 L** 04742

360 × 270 × H220 mm | 5





# Infinity

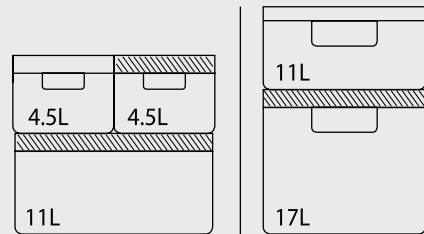

**1. BOX PLAIN + LID ~30 L 01718**  
560 × 390 × H180 mm | 5



**2. BOX PLAIN + LID ~45 L 01721**  
560 × 390 × H270 mm | 5



**3. BOX PLAIN + LID ~4.5 L 04746**  
270 × 190 × H120 mm | 5



**4. BOX PLAIN + LID ~11 L 04752**  
360 × 270 × H140 mm | 5



**5. BOX PLAIN + LID ~17 L 04743**  
360 × 270 × H220 mm | 5



6



7



8



**6. DRAWER PLAIN**  
4 × ~11 L 04355

300 × 360 × H690 mm | 1



**7. DRAWER DOTS**  
4 × ~11 L 04356

300 × 360 × H690 mm | 1



**8. KNOCK DOWN DRAWER DOTS**  
4 × ~11 L 02064

300 × 360 × H690 mm | 1



## Infinity DRAWERS



# Infinity DIVIDER



CURVER

**1. DIVIDER L ~1 L 01725**  
300 × 80 × H50 mm | 12



**2. DIVIDER M ~0.7 L 01724**  
230 × 80 × H50 mm | 12



**3. DIVIDER XS SET 3 × ~0.2 L 01722**  
80 × 80 × H50 mm | 8



**4. DIVIDER XL ~1.5 L 01727**  
230 × 150 × H50 mm | 6



**5. DIVIDER S ~0.45 L 01723**  
150 × 80 × H50 mm | 12



**6. DIVIDER SQUARE ~1 L 01726**  
150 × 150 × H50 mm | 6







# Knit BASKET



1



4



2



3



5



6



7



8



9

1. BASKET XS ~3 L 03675

250 × 175 × H140 mm | 5



2. BASKET S ~8 L 03674

300 × 220 × H170 mm | 5



3. BASKET L ~19 L 03670

400 × 300 × H230 mm | 5



4. BASKET ROUND L ~30 L 03673

400 × 390 × H330 mm | 5



5. BASKET XS ROUND ~3 L 03671

230 × 190 × H190 mm | 5



6. BASKET A6 ~1.3 L 00772

190 × 140 × H70 mm | 8



7. BASKET ROUND S ~0.6 L 00775

∅100 × H110 mm | 8



8. BASKET A4 ~4.5 L 00778

350 × 270 × H70 mm | 8







9. BASKET A5 ~2.6 L 00771

260 × 200 × H70 mm | 8







- 1. BASKET ROUND S ~0.7 L 00716**  
 ø105 × H110 mm | 8 
- 2. BASKET ROUND L ~1.6 L 00717**  
 ø144 × H140 mm | 8 
- 3. BASKET A6 00097**  
 198 × 142 × H60 mm | 8 
- 4. BASKET A5 00096**  
 256 × 200 × H60 mm | 8 
- 5. BASKET A4 00095**  
 358 × 262 × H60 mm | 8 

# My Style



6



7



8



9



# My Style BASKET

**6. BASKET S ~4 L 03610**

255 × 196 × H103 mm | 6 



**7. BASKET M ~13 L 03611**

355 × 296 × H133 mm | 4 



**8. BASKET L ~18 L 03612**

355 × 296 × H220 mm | 4 



**9. BASKET SQUARE ~25 L 03613**

325 × 325 × H280 mm | 4 





# Your Style BASKET

**1. BASKET S ~4 L 04758**  
260 × 190 × H100 mm | 6



**2. BASKET M ~13 L 04757**  
350 × 300 × H130 mm | 4



**3. BASKET L ~18 L 04756**  
350 × 300 × H220 mm | 4

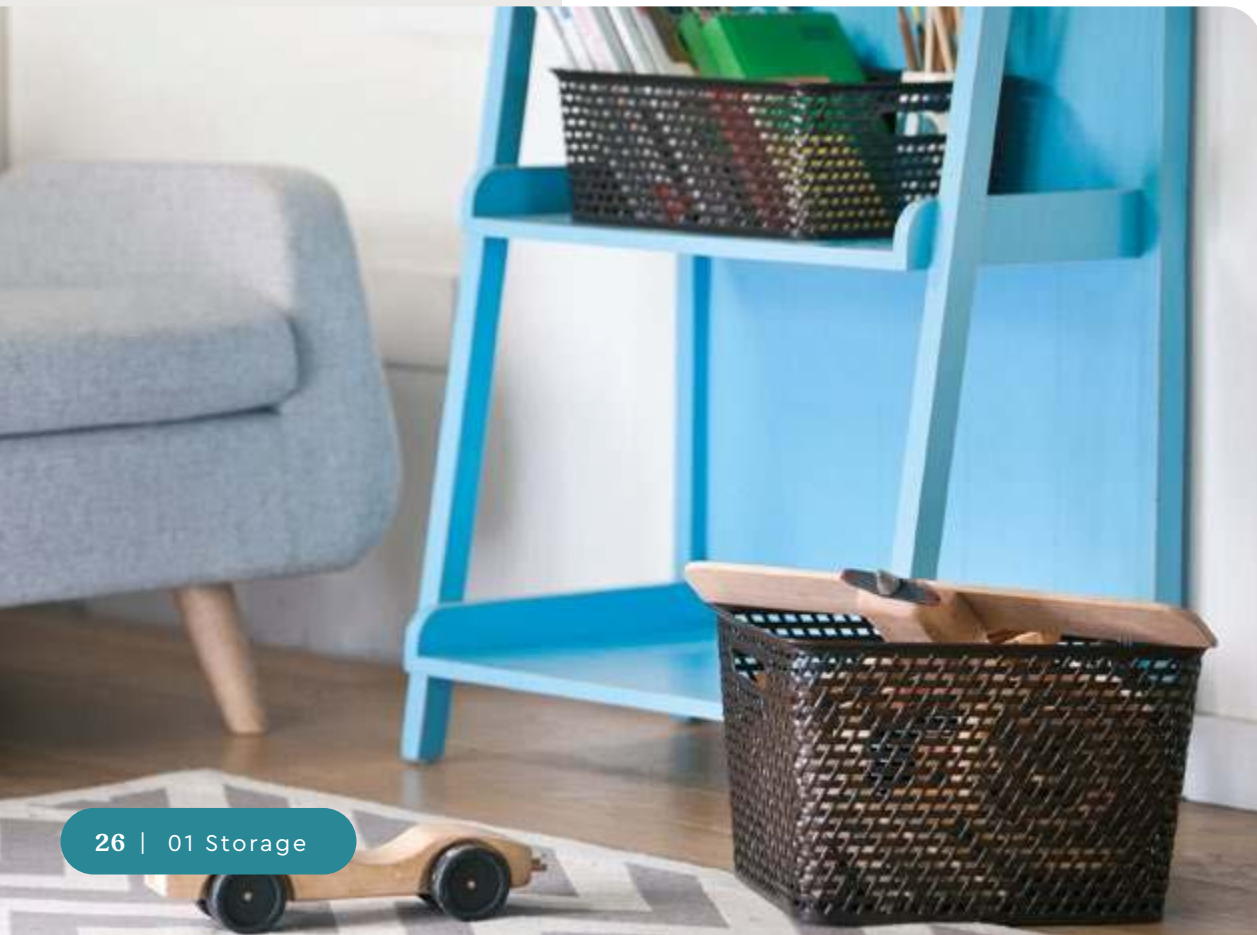

1



2



3



4



5



6



**4. BASKET S ~6 L 17197396**  
280 × 180 × H130 mm | 6



**5. BASKET M ~18 L 17197397**  
390 × 280 × H180 mm | 6



**6. BASKET L ~30 L 17197398**  
430 × 330 × H230 mm | 3



# Nuance BASKET



# Stockholm BOX

1. ART DECO L ~22 L 04711  
395 × 295 × H235 mm | 5

2. MODERN LEAVES L ~22 L 04711  
395 × 295 × H235 mm | 5

3. LEATHER L ~22 L 04711  
395 × 295 × H235 mm | 5

4. DOTS L ~22 L 04711  
395 × 295 × H235 mm | 5

5. ROMANCE L ~22 L 04711  
395 × 295 × H235 mm | 5



1



2



3



4



5



6



7



8



9

6. MODERN LEAVES S ~6 L 04710  
295 × 195 × H135 mm | 4

7. DOTS S ~6 L 04710  
295 × 195 × H135 mm | 4

8. ROMANCE S ~6 L 04710  
295 × 195 × H135 mm | 10

9. LEATHER S ~6 L 04710  
295 × 195 × H135 mm | 10





# T Box

new

**1. STORAGE BOX + LID S**  
~14 L 00695

265 × 380 × H190 mm | 5 



**2. STORAGE BOX + LID M**  
~20 L 00696

265 × 380 × H285 mm | 5 



**3. STORAGE BOX + LID L**  
~32 L 00697

390 × 555 × H190 mm | 7 



**4. STORAGE BOX + LID XL**  
~47 L 00698

390 × 555 × H285 mm | 5 



**5. STORAGE BOX + LID XXL**  
~70 L 00699

390 × 555 × H425 mm | 3 





# Sistemo ORGANIZER



- 1. ORGANIZER 10018  
390 × 240 × H50 mm | 10
- 2. ORGANIZER 10017  
375 × 150 × H50 mm | 10
- 3. ORGANIZER 10014  
375 × 75 × H50 mm | 10
- 4. ORGANIZER 10013  
300 × 75 × H50 mm | 10
- 5. ORGANIZER 10012  
225 × 75 × H50 mm | 10

- 6. ORGANIZER 10010  
75 × 75 × H50 mm | 10
- 7. ORGANIZER 10015  
150 × 150 × H50 mm | 10
- 8. ORGANIZER 10016  
225 × 155 × H50 mm | 10
- 9. ORGANIZER 10011  
150 × 75 × H50 mm | 10





# Optima & Vanity BOXES

**1. BOX ~15 L 00032**  
374 × 280 × H210 mm | 8



**2. BOX ~30 L 00033**  
428 × 340 × H281 mm | 6



**3. BOX + LID ~9.5 L 05002**  
370 × 220 × H175 mm | 12



**4. BOX + LID ~14 L 05001**  
370 × 220 × H255 mm | 8



**5. BOX + LID ~30 L 05000**  
455 × 360 × H255 mm | 6



# Textile BOX



- 6. BOX ~1.8 L 03006**  
195 × 167 × H85 mm | 6
- 7. BOX ~5.7 L 03003**  
343 × 195 × H125 mm | 7
- 8. BOX ~10 L 03007**  
342 × 297 × H125 mm | 6
- 9. BOX ~18.5 L 03002**  
396 × 343 × H173 mm | 6
- 10. BOX ~33 L 03000**  
395 × 342 × H343 mm | 5
- 11. BOX ~45 L 03008**  
596 × 394 × H230 mm | 4





# Multiboxx & Essential

**1. CONTAINER ~3 L 00363**  
260 × 180 × H110 mm | 6



**2. CONTAINER ~6 L 00364**  
260 × 200 × H240 mm | 6



**3. BOX + LID ~16 L 00753**  
300 × 390 × H210 mm | 5



**4. BOX + LID ~26 L 00755**  
340 × 440 × H270 mm | 5



**5. BOX + LID ~45 L 00756**  
400 × 570 × H300 mm | 5

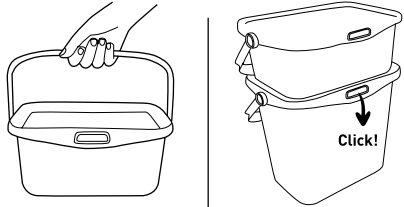

## E-box



**6. E-BOX M 01788**  
360 × 140 × H120 mm  
8





# Ribbon & Victoria BASKETS



**1. RIBBON BASKET S ~8 L 00718**

270 × 210 × H170 mm | 5



**2. RIBBON BASKET XS ~3.3 L 00728**

240 × 170 × H120 mm | 5



**3. VICTORIA BASKET ~2.7 L 02204**

220 × 170 × H120 mm | 6



**4. VICTORIA BASKET ~4.3 L 02205**

290 × 210 × H160 mm | 6



1



2



3



4

**5. BASKET S 15164**

312 × 181 × H106 mm | 8



**6. BASKET M 15165**

350 × 251 × H156 mm | 6



**7. BASKET L 15166**

406 × 304 × H156 mm | 6



**8. BASKET XL 15167**

430 × 314 × H258 mm | 4



5



6



7



8

# Alfa BASKET







# Drawers



1



2



3

**1. DRAWER 5 x ~20 L 06770**

370 x 390 x H1000 mm | 1



**2. DRAWER 4 x ~20 L 06771**

370 x 390 x H805 mm | 1



**3. DRAWER 3 x ~20 L 06772**

370 x 390 x H610 mm | 1





# 02

## WASTE

Kosze na śmieci | Корзины для мусора | Szeméttárolás



Welcome home

CURVER





# Ready To Collect



**1. BIN ~5 L 02100**  
250 × 186 × H203 mm | 6

**2. BIN ~10 L 02101**  
250 × 186 × H329 mm | 6

**3. BIN ~20 L 02102**  
367 × 246 × H331 mm | 6

**4. BIN ~30 L 02103**  
367 × 246 × H551 mm | 6





# Swing Top BINS

new



1. BIN ~10 L 03984

246 × 198 × H373 mm

6



2. BIN ~15 L 03985

306 × 248 × H418 mm

6



3. BIN ~25 L 03986

346 × 278 × H511 mm

4



4. BIN ~50 L 03987

406 × 340 × H668 mm

3



# Flip BINS



5. BIN ~9 L 02170

189 × 235 × H350 mm | 4



6. BIN ~25 L 02171

260 × 340 × H470 mm | 4



7. BIN ~45 L 02172

294 × 376 × H653 mm | 4



8. NEW YORK ~25 L 02171

260 × 340 × H470 mm | 4

9. PARIS ~25 L 02171

260 × 340 × H470 mm | 4

10. LONDON ~25 L 02171

260 × 340 × H470 mm | 4

11. LEATHER ~25 L 02171

260 × 340 × H470 mm | 4





# Chic & Deco BINS

**1. PEDAL BIN M ~25 L 8071800**

270 × 410 × H450 mm | 4 



**2. PEDAL BIN L ~45 L 8071900**

290 × 450 × H610 mm | 3 



**3. METAL BIN ~40 L 02150**

309 × 349 × H697 mm | 1 



**4. METAL BIN ~15 L 02120**

303 × 268 × H448 mm | 1 



**5. METAL BIN ~5 L 02160**

235 × 211 × H277 mm | 1 



**CURVER**

**6. DUO BIN ~23+23 L 08680**

390 × 290 × H720 mm | 1 



**7. METAL BIN ~10+18 L 02165**

290 × 390 × H505 mm | 1 



**8. METAL BIN ~30 L 02164**

390 × 330 × H510 mm | 1 



**9. METAL BIN ~50 L 02162**

390 × 290 × H730 mm | 2 



**10. KITCHEN ~50 L 02162**

390 × 290 × H730 mm | 2 

**11. BLACK ~50 L 02162**

390 × 290 × H730 mm | 1 



1. METAL BIN ~40 L 02340  
393 × 250 × H607 mm | 1

2. METAL BIN ~25 L 02339  
393 × 250 × H454 mm | 1

3. DUO BIN ~26+26 L 01129  
486 × 284 × H615 mm | 1

4. BIN ~65 L 01128  
486 × 284 × H615 mm | 1

# Slim BINS & Deco BINS LARGE

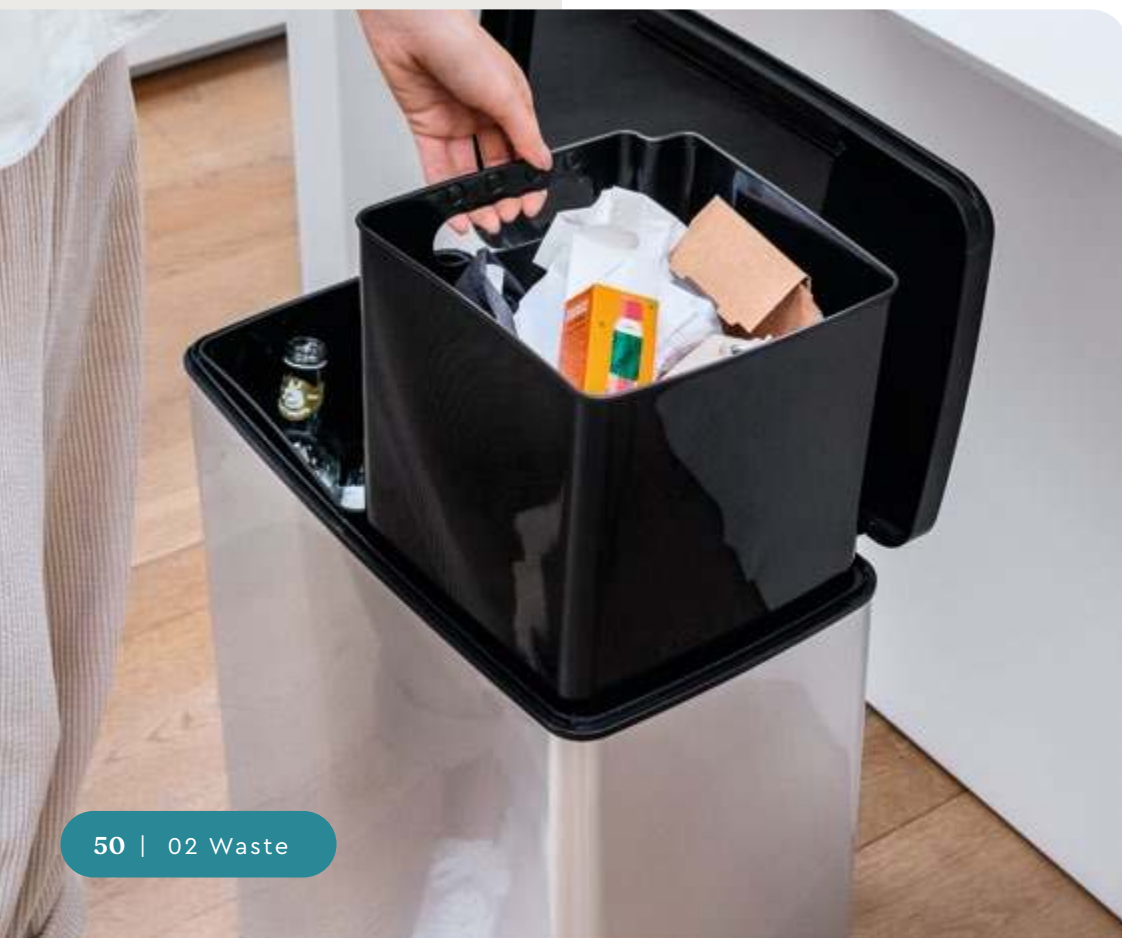

## Compatta BINS

5. COMPATTA DUO BIN  
~23+23 L 17210792  
496 × 294 × H620 mm | 1

6. COMPATTA BIN ~50 L 17210793  
496 × 294 × H620 mm | 5

7. COMPATTA DUO BIN  
~23+23 L 17210792  
496 × 294 × H620 mm | 1

8. COMPATTA BIN ~50 L 17210793  
496 × 294 × H620 mm | 5



# Click-it BINS



1



2



3



4

**1. BIN ~9 L 04042**  
229 × 189 × H381 mm | 12



**2. BIN ~15 L 04043**  
280 × 235 × H438 mm | 8



**3. BIN ~25 L 04044**  
325 × 265 × H505 mm | 6



**4. BIN ~50 L 04045**  
385 × 335 × H635 mm | 4



# Waste BINS



5



6



7



8



9



10



**5. BIN ~50 L 03977**  
407 × 306 × H725 mm | 5



**6. BIN ~50 L 03931**  
ø390 × H690 mm | 6



**7. STEP ON BIN ~15 L 14011**  
335 × 275 × H362 mm | 6



**8. STEP ON BIN ~25 L 03956**  
ø360 × H410 mm | 2



**9. BIN ~10 L 05312**  
200 × 250 × H360 mm | 12



**10. BIN ~25 L 05322**  
365 × 291 × H480 mm | 8





1. DUO BIN ~21 L 04027  
400 × 300 × H405 mm | 1



2. TRIO BIN ~40 L 03942  
478 × 394 × H592 mm | 1



3. BIN ~20 L 00759  
300 × 290 × H430 mm | 5



4. BIN ~40 L 00760  
375 × 330 × H550 mm | 3



1



2



## Duo & Trio BIN

## Essential BINS

3



4



easy to clean

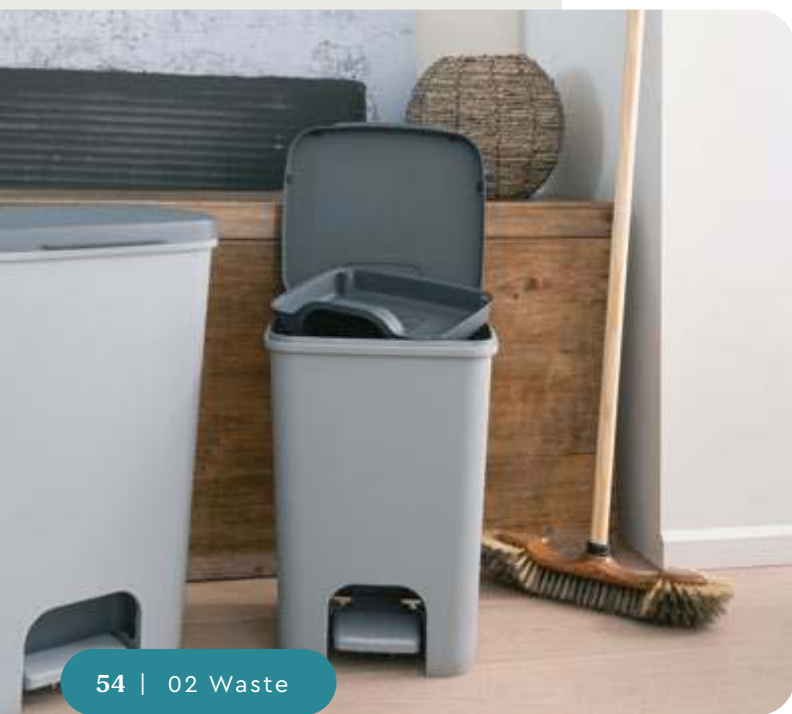

5



6



7



5. KNIT PAPER BIN ~7 L 03678  
ø240 × H270 mm | 5



6. BIN ~10 L 04022  
ø270 × H295 mm | 14



7. TIGER BIN ~12 L 07123  
ø265 × H385 mm | 4

## Paper BINS



# Waste SEPARATION

**1. LID FOR REFUSE BIN 15001**

250 × 190 × H25 mm | 66 



**2. REFUSE BIN ~6 L 01502**

250 × 190 × H295 mm | 8 



**3. REFUSE BIN ~10 L 01501**

250 × 190 × H420 mm | 8 



**4. REFUSE BIN SET**

2 × ~10 + 6 L 08993

250 × 190 × H450 mm | 6 



**5. MULTIBOXX BIO ~3 L 00363**

260 × 180 × H110 mm | 6 



**6. MULTIBOXX BIO ~6 L 00364**

260 × 200 × H240 mm | 6 



**7. BINS SET 3 × ~9 L 02173**

190 × 235 × H365 mm | 1 



**8. BINS SET 3 × ~25 L 02174**

330 × 255 × H495 mm | 1 



1



2



3



4



5



6



# ECO Friendly BINS



7



8





# 03

## KITCHEN

Kuchnia | Кухня | Кухня



Welcome home







# Vedo



### 1. FOOD KEEPER ~0.5 L 03845

160 × 120 × H50 mm | 6



### 2. FOOD KEEPER ~0.75 L 03846

160 × 120 × H70 mm | 6



### 3. FOOD KEEPER ~1.0 L 03847

200 × 140 × H60 mm | 6



### 4. FOOD KEEPER ~1.3 L 03848

200 × 140 × H80 mm | 6



### 5. FOOD KEEPER ~1.75 L 03849

230 × 170 × H70 mm | 4



### 6. FOOD KEEPER ~2.0 L 03850

230 × 170 × H80 mm | 4



### 7. FOOD KEEPER ~4.0 L 03851

290 × 200 × H100 mm | 6



1



2



3



4



5



6



7



8



9



10



11



12



### 8. FOOD KEEPER SET 2 × ~1.3 L 03510

200 × 140 × H80 mm | 8



### 9. FOOD KEEPER SET 5 × ~0.25 L 03844

110 × 90 × H60 mm | 6



### 10. FOOD KEEPER SET 5 × ~0.5 L 03507

160 × 120 × H50 mm | 6



### 11. FOOD KEEPER SET 4 × ~0.75 L 03508

160 × 120 × H70 mm | 6



### 12. FOOD KEEPER SET 3 × ~1.0 L 03505

200 × 140 × H60 mm | 6



## CURVER





# Snap Box



**1. FOOD KEEPER ~0.25 L** 17211849

120 × 85 × H40 mm | 12



**2. FOOD KEEPER ~0.4 L** 17211850

130 × 100 × H50 mm | 12



**3. FOOD KEEPER ~0.9 L** 17211851

145 × 150 × H60 mm | 8



**4. FOOD KEEPER ~1.3 L** 17211852

210 × 155 × H60 mm | 6



**5. FOOD KEEPER ~4.4 L** 17211853

330 × 245 × H80 mm | 6



**6. FOOD KEEPER ~1.8 L WITH DIVIDER** 17211854

220 × 170 × H70 mm | 6



**7. FOOD KEEPER ~3.3 L WITH DIVIDER** 17211855

223 × 173 × H70 mm | 6





# SMART Eco To Go



Now available from 100% recycled polypropylene, Smart Eco Line is aimed at eco-responsible consumers, concerned about the preservation of natural resources but also about the safety of the products they buy on their health.

Linia Smart Eco, wykonana z polipropylenu w 100% pochodzącego z recyklingu, jest przeznaczona dla konsumentów myślących o ekologii – dbających o ochronę zasobów naturalnych, ale także o bezpieczeństwo kupowanych przez nich produktów dla ich zdrowia.

Линейка Smart Eco, изготовленная из полипропилена на 100% вторичного происхождения, предназначена для потребителей, заботящихся об экологии – не только об охране природных ресурсов, но и о том, чтобы приобретаемая продукция была безопасна для их здоровья.

A 100%-ban újrafeldolgozott polipropilénből készült Smart Eco termékcsalád az ökológia iránt elkötelezett – a természetes erőforrások védelmére, de egyben a vásárolt termékek saját egészsége szempontjából biztonságos voltára is gondoló fogyasztók számára készült.



**CURVER**

**1. LUNCH KIT ~1.6 L 00921**

ø220 × H100 mm | 6 ♻️



**2. LUNCH KIT ~1 L 00953**

ø200 × H70 mm | 6 ♻️



**3. NOODLES ~0.9 L 00952**

ø160 × H100 mm | 6 ♻️



**4. LUNCH KIT ~1.2 L 00947**

200 × 150 × H90 mm | 6 ♻️



**5. LUNCH ~1 L 00946**

200 × 150 × H70 mm | 6 ♻️



**6. LUNCH ~0.9 L 00949**

160 × 160 × H70 mm | 6 ♻️



1



2



3



4



5



6





# SMART Eco To Go



1



2



3



4



5



6



7



8



9



1. CUP S 00739  
ø110 × H110 mm | 6



2. CUP L 00769  
ø110 × H170 mm | 6



3. SET OF 3 SAUCE CUPS  
3 × ~0.08 L 00956  
ø70 × H100 mm | 6



4. SNACK ~0.2 L 00944  
120 × 90 × H50 mm | 8



5. LUNCH KIT ~1.1 L 00950  
160 × 160 × H90 mm | 6



6. DUAL ~0.6 + 0.3 L 00925  
200 × 150 × H70 mm | 6



7. SANDWICH ~0.7 L 00945  
200 × 150 × H50 mm | 8



8. SET ~0.6 + 0.6 + 0.3 + 1 + 1.2 L 08176  
425 × 165 × H215 mm | 1



9. SET ~0.4 + 0.4 + 1 + 1.1 L 08177  
425 × 165 × H215 mm | 1







# SMART ECO Microwave



LATCHES



VALVE

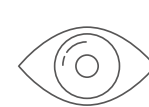

TRANSPARENT LID

**1. NOODLES ~0.9 L 00933**

ø160 × H100 mm | 6



**2. STEAMER ~1.6 L 00943**

ø220 × H100 mm | 6



**3. STEAMER ~1.1 L 00941**

160 × 160 × H90 mm | 6



**4. STEAMER ~1.2 L 00939**

203 × 154 × H88 mm | 6



1



2



3



4





1. RECTANGULAR ~0.2 L 00923

117 × 89 × H52 mm | 8



2. SQUARE ~0.9 L 00937

161 × 161 × H72 mm | 6



3. SQUARE ~1.1 L 00938

160 × 160 × H90 mm | 6



4. RECTANGULAR ~0.7 L 00924

203 × 154 × H52 mm | 8



5. RECTANGULAR ~1 L 00935

200 × 150 × H70 mm | 6



6. RECTANGULAR ~1.2 L 00936

200 × 150 × H90 mm | 6



7. RECTANGULAR ~2 L 01122

288 × 200 × H65 mm | 6



# SMART ECO Fresh



8



9



10



11

**CURVER**

8. RECTANGULAR ~3.5 L 01120

331 × 245 × H76 mm | 6



9. RECTANGULAR ~3.5 L 01121

288 × 200 × H105 mm | 6



10. SET ~0.9 + 1 + 1.1 + 1.2 L 08174

425 × 165 × H215 mm | 1



11. RECTANGULAR ~5 L 04058

288 × 200 × H145 mm | 6





# SMART To Go



**1. NOODLES ~0.9 L** 00952

ø160 × H100 mm | 6



**2. LUNCH KIT ~1.1 L** 00950

160 × 160 × H90 mm | 6



**3. LUNCH KIT ~1.2 L** 00947

200 × 150 × H90 mm | 6



LATCHES



VALVE



TRANSPARENT LID

1



2



3



# SMART Fresh

CURVER



4



5



6

**4. SQUARE ~0.9 L** 00937

160 × 160 × H70 mm | 6



**5. RECTANGULAR ~1 L** 00935

200 × 150 × H70 mm | 6



**6. RECTANGULAR ~1.2 L** 00936

200 × 150 × H90 mm | 6





# SMART Flexi



CURVER



1. SQUARE ~0.9 L 00424

160 × 160 × H70 mm | 6



2. RECTANGULAR ~1 L 00422

200 × 150 × H70 mm | 6



3. SQUARE ~1.1 L 00421

160 × 160 × H90 mm | 6



4. RECTANGULAR ~1.2 L 00423

200 × 150 × H90 mm | 6





# SMART Cook



**10**  
YEAR  
Guarantee

BOROSILICATE  
**GLASS**  
SHATTER RESISTANT

LATCHES

VALVE

TRANSPARENT LID



1



2



3



4



5



6



**CURVER**

1. GLASS RECTANGULAR ~3.7 L 04060

330 × 255 × H90 mm | 4



2. GLASS RECTANGULAR ~2.3 L 04059

290 × 200 × H80 mm | 4



3. GLASS SQUARE ~0.7 L 00115

150 × 160 × H70 mm | 4



4. GLASS RECTANGULAR ~0.9 L 00114

200 × 150 × H70 mm | 4



5. GLASS ROUND ~0.6 L 00117

∅160 × H70 mm | 4



6. GLASS ROUND ~1.2 L 00116

∅200 × H110 mm | 4





# Grand Chef ECO



**1. RECTANGULAR ~2.4 L 07399**  
200 × 150 × H125 mm | 8



**2. RECTANGULAR ~2.6 L 00009**  
300 × 200 × H65 mm | 8



**3. RECTANGULAR ~4 L 00010**  
300 × 200 × H94 mm | 4



**4. RECTANGULAR ~5.4 L 00011**  
300 × 200 × H125 mm | 4



**5. RECTANGULAR ~0.5 L 00007**  
150 × 100 × H65 mm | 8



**6. RECTANGULAR ~0.75 L 00008**  
150 × 100 × H93 mm | 8



**7. SQUARE ~0.75 L 00013**  
150 × 150 × H65 mm | 6



**8. SQUARE ~1.2 L 00014**  
150 × 150 × H93 mm | 6



**9. RECTANGULAR ~1.2 L 07379**  
200 × 150 × H65 mm | 8



**10. RECTANGULAR ~1.8 L 07389**  
200 × 150 × H93 mm | 8







# Fresh&Go



Click !

**1. ROUND ~0.5 L** 00563

ø125 × H65 mm | 6



**2. ROUND ~1 L** 00564

ø125 × H125 mm | 6



**3. SQUARE ~0.25 L** 00557

105 × 105 × H44 mm | 6



**4. SQUARE ~0.45 L** 00558

105 × 105 × H70 mm | 6



**5. SQUARE ~0.8 L** 00559

155 × 155 × H55 mm | 6



**6. SQUARE ~1.2 L** 00560

155 × 155 × H83 mm | 6

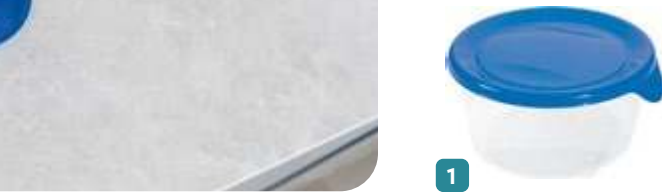

1



2



3



4



5



6



7



8



9



10



11



12



13



**CURVER**

**7. SQUARE ~1.7 L** 00561

195 × 195 × H70 mm | 4



**8. SQUARE ~2.9 L** 00562

230 × 230 × H83 mm | 4



**9. RECTANGULAR ~0.5 L** 00553

167 × 127 × H46 mm | 8



**10. RECTANGULAR ~1 L** 00554

228 × 148 × H62 mm | 6



**11. RECTANGULAR ~2 L** 00555

256 × 167 × H72 mm | 4



**12. RECTANGULAR ~3 L** 00556

256 × 167 × H100 mm | 4



**13. RECTANGULAR ~5 L** 03071

300 × 200 × H130 mm | 6





1. SQUARE SET 3 x ~0.8 L 08559

155 x 155 x H110 mm | 6



2. SQUARE SET 3 x ~1.2 L 08560

155 x 155 x H120 mm | 6



3. SQUARE SET ~0.25 + 0.8 + 1.7 L 08924

195 x 195 x H70 mm | 6



4. SQUARE SET

~0.25 + 0.8 + 1.7 + 2.9 L 08927

230 x 230 x H83 mm | 6



5. RECTANGULAR SET

~0.5 + 1 + 2 L 08026

260 x 170 x H74 mm | 6



6. SQUARE SET 3 x ~0.8 L 08559

155 x 155 x H110 mm | 6



7. RECTANGULAR SET

~0.5 + 1 + 2 L 08026

260 x 170 x H74 mm | 6



8. SQUARE SET 4 x ~0.25 L 08045

105 x 105 x H98 mm | 6



9. SQUARE SET 4 x ~0.45 L 08046

105 x 105 x H135 mm | 6



# Fresh&Go



8



9



CURVER



# Take Away



1. ROUND LOW 3 × ~0.5 L 00471

ø130 × H110 mm | 12



2. ROUND DEEP 2 × ~1 L 00472

ø130 × H190 mm | 12



1



2



**CURVER**



3. RECTANGULAR ~0.4 L 03870

125 × 90 × H60 mm | 24



4. RECTANGULAR ~0.8 L 03871

155 × 115 × H70 mm | 20



5. RECTANGULAR ~1.2 L 03872

175 × 130 × H80 mm | 10



6. RECTANGULAR ~2 L 03873

205 × 150 × H97 mm | 10



7. RECTANGULAR ~3 L 03874

225 × 168 × H108 mm | 8



8. RECTANGULAR ~4 L 03875

250 × 185 × H123 mm | 8



## Basic FOOD KEEPERS





# Dots bottles



**1. DOTS BOTTLE ~0.45 L 00280**

ø64 × H200 mm | 6



**2. DOTS BOTTLE ~0.75 L 00281**

ø70 × H250 mm | 6



**CURVER**

## Lunch & Go



**3. CUP S ~0.4 L 00739**

ø110 × H110 mm | 6



**4. LUNCH BOX ~1.4 L 00768**

230 × 130 × H70 mm | 6





# Dry Food Keepers

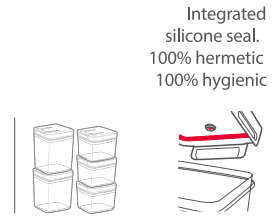

1. SQUARE ~0.8 L 00995

120 × 120 × H100 mm | 6



2. SQUARE ~1.3 L 00996

120 × 120 × H150 mm | 6



3. SQUARE ~1.8 L 00997

120 × 120 × H200 mm | 6



4. SQUARE ~2.3 L 03512

120 × 120 × H245 mm | 6



5. DRY GRAND CHEF ~0.8 L 04341

150 × 90 × H95 mm | 12



6. DRY GRAND CHEF ~1.6 L 04342

150 × 90 × H190 mm | 12



7. COFFEE BOX + SPOON ~1 L 01396

ø130 × H120 mm | 12



8. COFFEE BOX + SPOON ~1.7 L 01397

ø130 × H190 mm | 8



1



2



3



4



5



6



7



8





# Cake boxes



1



2



3

1. ROUND 00416  
 ø347 × H156 mm | 4



2. BUTLER PARTY BOX 00415  
 295 × 450 × H111 mm | 4



3. MICROWAVE  
 PLATE COVER 05213  
 ø270 × H89 mm | 14



# Essentials ACCESSORIES



4



5



6



7



8



9



4. SPOON COLANDER 00734  
 323 × 140 × H68 mm | 6



5. MIXING BOWL ~2.5 L 00732  
 231 × 203 × H120 mm | 6



6. MIXING BOWL ~3.5 L 00733  
 258 × 228 × H150 mm | 6



7. REVERSIBLE TRAY 00738  
 308 × 430 × H35 mm | 6



8. SQUEEZER 00737  
 178 × 152 × H116 mm | 6



9. ROUND COLANDER 00736  
 260 × 230 × H132 mm | 6





**1. MIXING BOWL SET**  
~1.5 + 2 + 2.5 L 03411  
ø222 × H123 mm | 12



**2. COLANDER** 03413  
266 × 225 × H116 mm | 20



**3. CUTLERY TRAY** 05752  
300 × 420 × H64 mm | 5



**4. BREAD BOX** 03515  
388 × 255 × H160 mm | 4



**5. SERVING TRAY** 03406  
325 × 430 × H10 mm | 20



**6. CUTLERY TRAY 5 SECTION** 13421  
333 × 260 × H45 mm | 25



**7. CHEF@HOME CUTLERY DRYER** ~0.75 L 03410  
ø120 × H120 mm | 9



# Basic ACCESSORIES



**8. CUTLERY DRYER** 03412  
140 × 65 × H145 mm | 20



**9. SMALL DISH DRAINER + TRAY** 13402  
265 × 420 × H88 mm | 10



**10. DISH DRAINER + TRAY** 13401  
450 × 380 × H88 mm | 10



**11. ESSENTIALS RECTANGULAR DISH DRAINER** 00743  
390 × 290 × H101 mm | 5

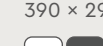

**12. ESSENTIALS SQUARE DISH DRAINER** 00742  
390 × 390 × H101 mm | 5

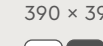



# 04

## LAUNDRY

Pralnia | Прачечная | Mosás



Welcome home

CURVER





# Jute

1. HAMPER ~58 L 08093  
430 × 340 × H600 mm | 6 



2. BASKET ~46 L 08091  
590 × 390 × H260 mm | 6 



# Infinity Recycled

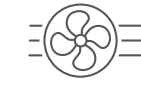

3. HAMPER ~60 L 04754  
440 × 350 × H600 mm | 6 



4. BASKET ~40 L 04755  
590 × 380 × H270 mm | 6 







**1. BASKET ~47 L 00745**  
600 × 390 × H280 mm | 6 ♻️

**2. HAMPER ~55 L 00713**  
430 × 330 × H600 mm | 6 ♻️



## My Style

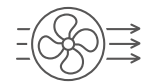

## Style

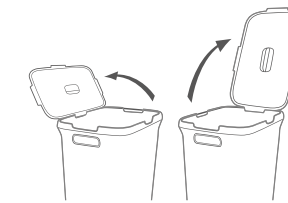

**3. HAMPER ~60 L 00707**  
448 × 341 × H615 mm | 4 ♻️



**4. HAMPER ~40 L 00709**  
448 × 265 × H615 mm | 4 ♻️



**5. BASKET ~45 L 00708**  
592 × 380 × H270 mm | 6 ♻️



**CURVER**



# Knit

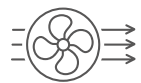

**1. HAMPER ~57 L 03676**  
452 × 341 × H614 mm | 4



**2. BASKET ~40 L 03677**  
595 × 385 × H270 mm | 4



**3. TOILET BRUSH 02004**  
ø140 × H430 mm | 4



**4. BATHROOM BIN ~7 L 00777**  
ø220 × H290 mm | 2



1



2



3



4



# Nuance



**5. HAMPER ~48 L 17197590**  
430 × 340 × H580 mm | 5



5



# Victor & Ribbon

**1. BASKET ~50 L 00048**  
590 × 385 × H244 mm | 5 



**2. HAMPER ~40 L 00047**  
397 × 299 × H500 mm | 5 



**3. HAMPER ~49 L 00746**  
460 × 270 × H590 mm | 5 

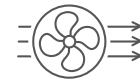

**4. IRONING BOARD 17181165**  
400 × 1430 × H94 mm | 1 





# 05

CURVER

## CLEANING

Utrzymanie czystości | Поддержание чистоты | Tisztítás



Welcome home





# Essentials

## BOWLS & BUCKET



**1. RECTANGULAR BOWL ~9 L 01728**  
300 × 380 × H130 mm | 8



**2. SQUARE BOWL ~12 L 01729**  
360 × 360 × H150 mm | 8



**3. ROUND BOWL ~4 L 01713**  
ø260 × H130 mm | 8



**4. ROUND BOWL ~6 L 01714**  
ø310 × H140 mm | 8



**5. ROUND BOWL ~10 L 01715**  
ø370 × H150 mm | 8



**6. ROUND BOWL ~16 L 01716**  
ø430 × H160 mm | 8



**7. BUCKET ~10 L 01709**  
ø280 × H270 mm | 12



1



2



3



4



5



6



7





# Basic BOWLS & BASINS

**1. ROUND BOWL ~4 L 13302**

ø260 × H114 mm | 20 



**2. ROUND BOWL ~6 L 13303**

ø300 × H120 mm | 10 



**3. ROUND BOWL ~9 L 13304**

ø360 × H125 mm | 10 



**4. ROUND BOWL ~18 L 13305**

ø450 × H152 mm | 10 



1



2



3



4



5



6



7



8



9



10

**CURVER**

**5. SQUARE BOWL ~7 L 05140**

262 × 262 × H108 mm | 22 



**6. SQUARE BOWL ~10 L 05141**

309 × 309 × H118 mm | 14 



**7. SQUARE BOWL ~14 L 05142**

358 × 358 × H129 mm | 10 



**8. ROUND BOWL WITH HANDLES ~27 L 03306**

ø510 × H205 mm | 6 



**9. TUB WITH HANDLES ~35 L 03315**

630 × 420 × H320 mm | 6 



**10. TUB WITH HANDLES ~55 L 03316**

750 × 500 × H330 mm | 6 





# Urban & Neon Mix

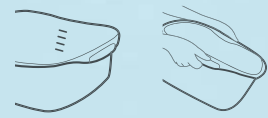

**1. SQUARE BOWL ~10 L 02337**  
380 × 340 × H145 mm | 6



**2. ROUND BOWL ~9 L 02335**  
355 × 385 × H145 mm | 6



**3. BASIN SQUARE ~7.2 L 00858**  
309 × 309 × H118 mm | 15



**4. BASIN SQUARE ~11 L 00859**  
358 × 358 × H129 mm | 15



1



2



3



4

# Buckets



5



6



7



8



9



10

**5. BINGO BUCKET ~10 L 01301**  
ø293 × H280 mm | 10



**6. BINGO BUCKET ~10 L 01301**  
ø293 × H280 mm | 10



**7. BUCKET ~10 L 03206**  
290 × 272 × H281 mm | 10



**8. BUCKET ~12 L 03207**  
305 × 295 × H290 mm | 7



**9. BUCKET ~16 L 03208**  
335 × 322 × H315 mm | 10



**10. SET BUCKET ~15 L + WRINGER 01336**  
395 × 300 × H220 mm | 6





# 06

## PETS



Welcome home





# Knit



## 1. COZY PET BED 17202851

ø540 × H202 mm | 1



## 2. COZY PET HOME 17202130

ø567 × H329 mm | 1



1



2



Knit texture technology



2 design options



2 soft cushions included



Knit texture technology

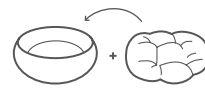

Soft cushion included



3



4



5

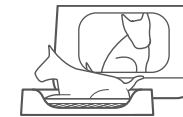

Two single beds



Two level bunk beds

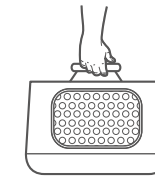

Pet carrier & crate

## 3. MULTIBOXX ~6 L 00364

260 × 200 × H240 mm | 6

## 4. MULTIBOXX ~3 L 00363

260 × 180 × H110 mm | 6

## 5. BUNK BED 3 IN 1 17201821

600 × 405 × H510 mm | 1





# Litter box & Carrier

## 1. CARRIER 00616

510 × 380 × H330 mm | 1 



## 2. CAT LITTER BOX 00615

510 × 385 × H400 mm | 1 

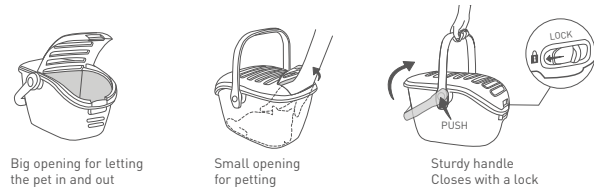

Big opening for letting the pet in and out

Small opening for petting

Sturdy handle  
Closes with a lock

1

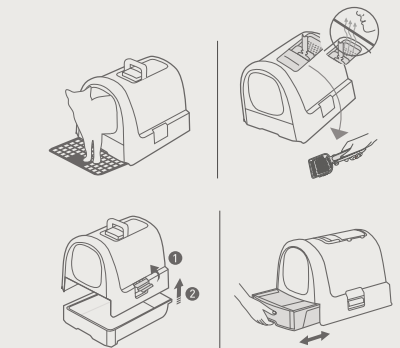

2



3

## 3. DOG HOUSE 17360369

950 × 990 × H990 mm | 1 



## 4. PET TRAVEL KIT 03908

190 × 180 × H180 mm | 6 



4



# Food Containers

1. CONTAINER 1.5 KG ~2 L 04346

205 × 86 × H194 mm | 6 

2. CONTAINER 10 KG ~23 L 03882

232 × 497 × H503 mm | 3 

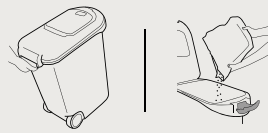
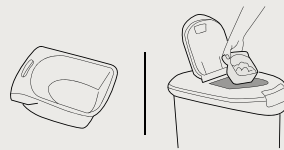

**CURVER**

3. CONTAINER 12 KG ~35 L 03905

493 × 278 × H430 mm | 3 

4. CONTAINER 20 KG ~54 L 03906

493 × 278 × H605 mm | 1 

5. CONTAINER 20 KG ~54 L 03906

493 × 278 × H605 mm | 1 

6. CONTAINER 6 KG ~15 L 03883

230 × 500 × H360 mm | 3 





# 07

## CAMPING

Kemping | Кемпинг | Kemping



Welcome home





# Coolbox

1. ICEPACK 400 GR SET-2 17211510

175 × 90 × H60 mm | 18 



2. COOLBOX ~10 L 16710

428 × 265 × H233 mm | 6 



1



2



CURVER



3



4



3. COOLBOX ~20 L 06720

428 × 265 × H396 mm | 1 



4. COOLBOX ~32 L 06732

498 × 333 × H410 mm | 1 





# 08

## DIY

Warsztat | Мастерская | Barkács



Welcome home







# Stack'N'Roll



**1. ORGANIZER** 17210772  
515 × 345 × H115 mm | 3



**2. TOOL BOX** 17210774  
525 × 345 × H260 mm | 2



**3. MOBILE CART** 17210777  
525 × 411 × H555 mm | 2



**4. HALF ORGANIZER** 17211433  
242 × 388 × H78 mm | 6



**5. TOOL CASE** 17211432  
526 × 341 × H148 mm | 3



**6. 2 DRAWERS** 17210832  
481 × 332 × H233 mm | 2



**7. SET 3 ORGANIZERS** 17210831  
481 × 332 × H233 mm | 2



**8. MOBILE SYSTEM** 17210365  
525 × 411 × H694 mm | 1







# Connect

**1. ORGANIZER ~12.6 L 17205287**  
540 × 302 × H114 mm | 6 



**2. 2 DRAWERS ~18.14 L 17208564**  
542 × 309 × H184 mm | 4 



**3. ROLLING SYSTEM ~88.4 L 17203038**  
565 × 373 × H700 mm | 1 



**4. TOOL BOX ~29.6 L 17205288**  
540 × 312 × H275 mm | 2 



**5. CART + ORGANIZER ~58.8 L 17205661**  
565 × 373 × H550 mm | 1 



1



2



4



3



5



6



7

**6. CANTILEVER ORGANIZER 22" ~14 L 17203103**  
565 × 317 × H161 mm | 4 



**7. CANTILEVER TOOL BOX 22" ~26 L 17203104**  
565 × 317 × H251 mm | 2 





# Gear

**1. TOOL CASE 22" ~14.5 L 17200380**  
564 × 350 × H165 mm | 3 



**2. ORGANIZER 22" ~13.17 L 17206659**  
560 × 345 × H128 mm | 4 



**3. TOOL BOX 22" ~36 L 17200382**  
564 × 350 × H310 mm | 2 



**4. MOBILE CART 22" ~56 L 17200383**  
564 × 465 × H480 mm | 2 



**5. CRATE 22" ~33.8 L 17202245**  
564 × 320 × H250 mm | 5 



**6. MOBILE TOOL BOX 28" 17210204**  
724 × 350 × H316 mm | 2 



**7. COOLER ~25.55 L 17208518**  
636 × 370 × H316 mm | 2 



1



3



5



6



2



4



7



8



9



10



11

KETER®

# Cantilever

**8. CANTI TRIO ORGANIZER 17198033**  
530 × 200 × H230 mm | 4 



**9. ORGANIZER 18" ~5.8 L 17186819**  
458 × 240 × H145 mm | 4 



**10. ORGANIZER 22" ~14 L 17185073**  
572 × 307 × H167 mm | 3 



**11. TOOL BOX 22" ~26 L 17187311**  
567 × 314 × H245 mm | 2 





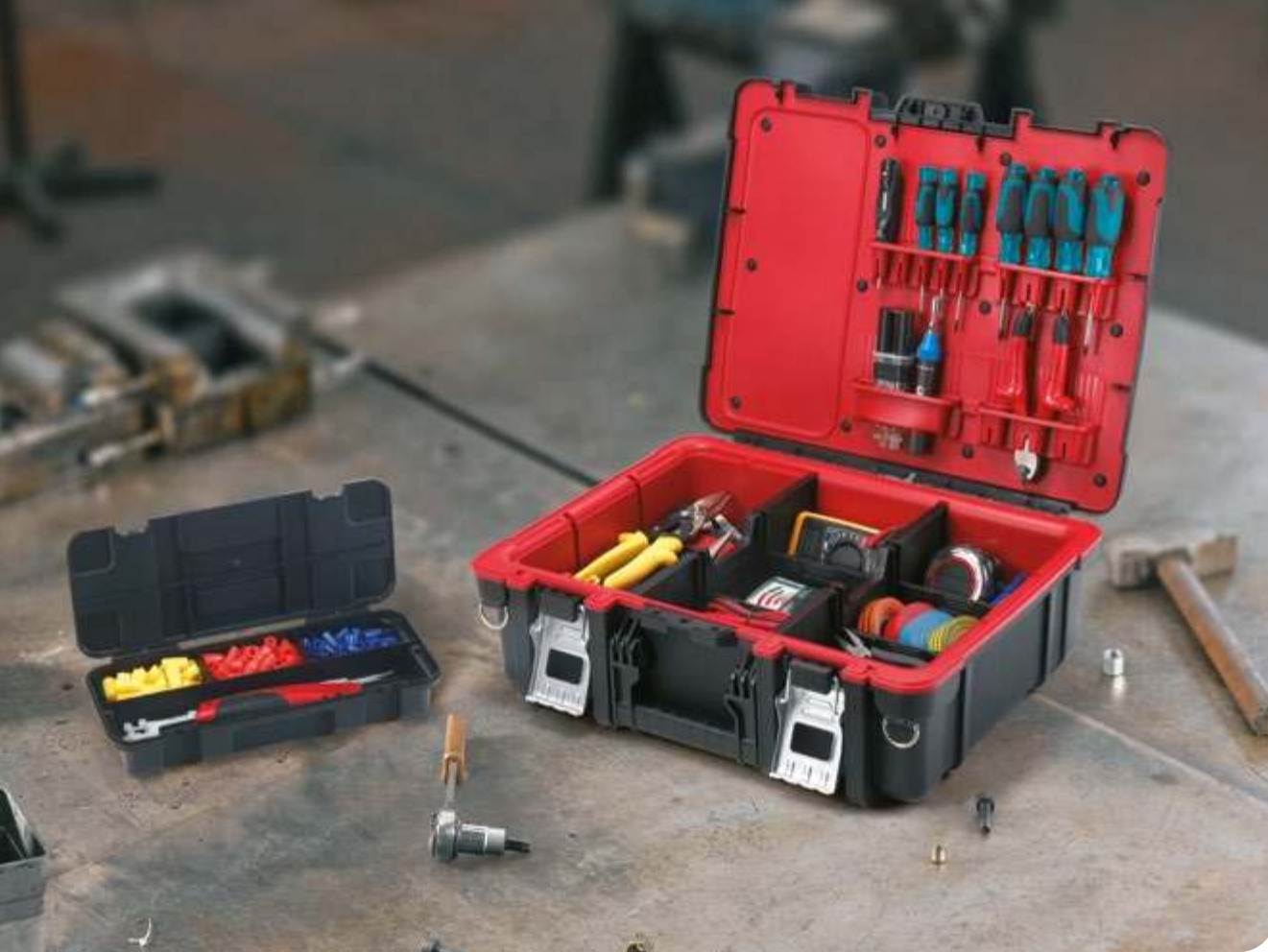

**1. TECHNICAL BOX ~16.3 L 17198036**

480 × 380 × H175 mm | 4 📦



**2. HAWK 26" ~35.6 L 17181010**

660 × 287 × H266 mm | 2 📦



**3. POWER TOOL BOX 16" ~16 L 17191708**

419 × 327 × H205 mm | 4 📦



2

# Tool Boxes



1



3



# Tool Carts

**4. CANTILEVER MOBILE CART**

JOB BOX ~57 L 17203037

646 × 373 × H410 mm | 2 📦



**5. MASTERLOADER ~65.3 L 17191709**

616 × 378 × H415 mm | 2 📦



4



5





# Work tables

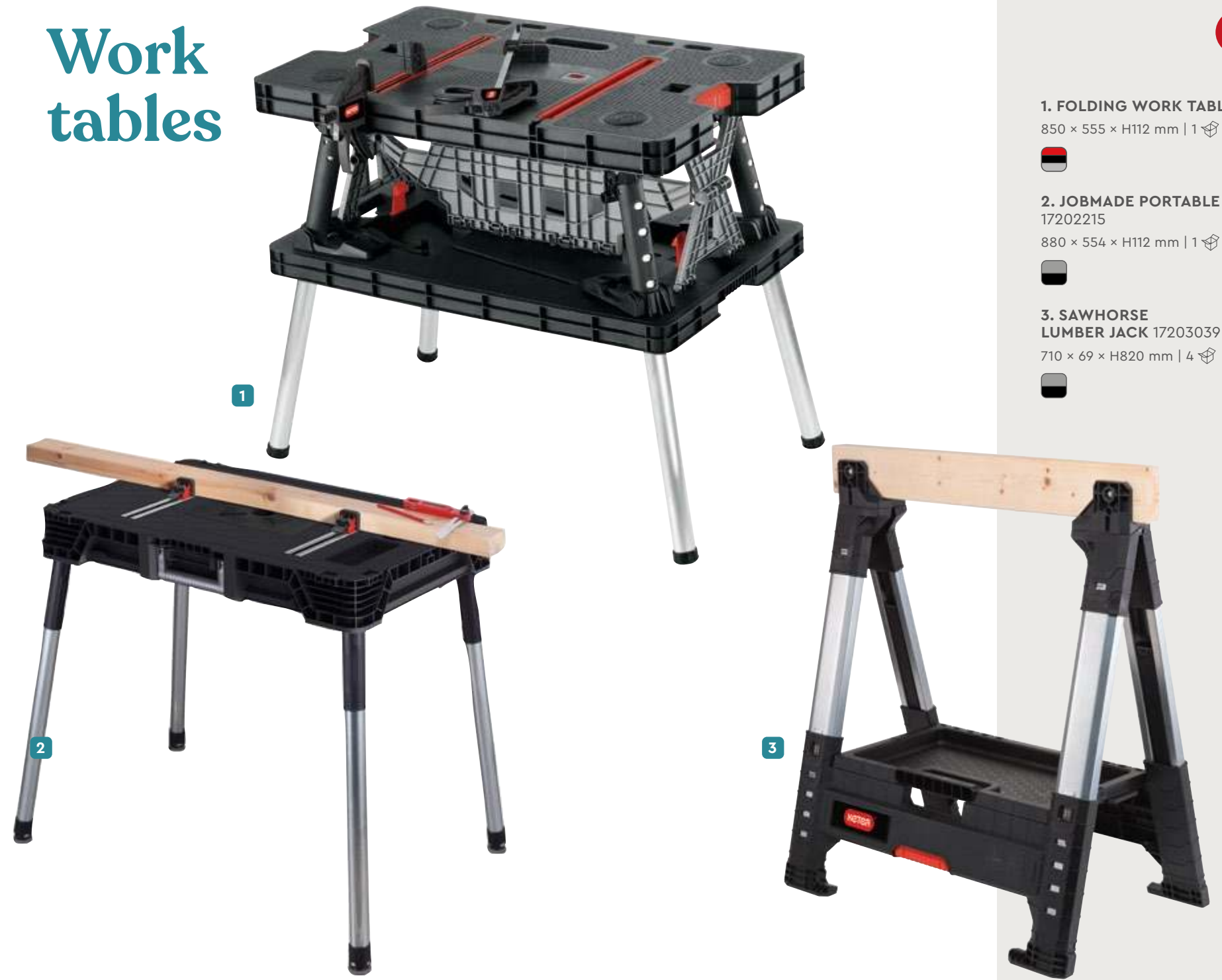

**1. FOLDING WORK TABLE 17182239**  
850 × 555 × H112 mm | 1



**2. JOBMADE PORTABLE TABLE 17202215**  
880 × 554 × H112 mm | 1



**3. SAWHORSE LUMBER JACK 17203039**  
710 × 69 × H820 mm | 4





# Tool chest

**1. 2 DRAWERS ~17.1 L 17199303**  
562 × 289 × H262 mm | 2



**2. 3 DRAWERS ~17.1 L 17199302**  
562 × 289 × H262 mm | 2



**3. 5 DRAWERS SET ~33.4 L 17199301**  
562 × 289 × H502 mm | 1



**4. 6 DRAWERS SET ~50.5 L 17201228**  
562 × 289 × H742 mm | 1

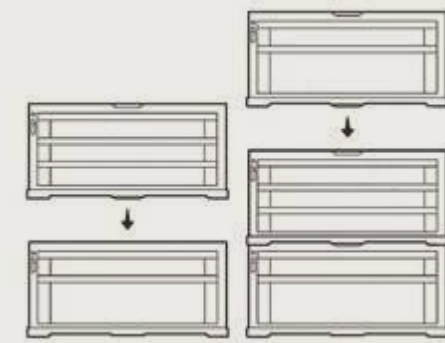



# Heroboxes

1. TOOL BOX SET 13" + 16" 02897

396 × 231 × H221 mm | 2 



2. TOOL BOX 16" 02899

395 × 230 × H220 mm | 2 



3. TOOL BOX 13" 02898

330 × 200 × H160 mm | 2 



1



138 | 8 DIY



2



3



made with  
HIGH  
RESISTANT  
PLASTIC

4



4. TOOL BOX 16" 02925

414 × 223 × H205 mm | 6 



5. TOOL BOX 20" 02934

510 × 260 × H250 mm | 4 



5



6. TOOL BOX 26" 02935

580 × 290 × H300 mm | 3 



6



## Premium

139



# Organizers

**1. ORGANIZER L 02921**  
250 × 186 × H52 mm | 8



**2. ORGANIZER S 07746**  
231 × 183 × H71 mm | 6



**3. ORGANIZER L 07747**  
264 × 267 × H71 mm | 6



**4. DRAWER CABINET 07752**  
290 × 170 × H270 mm | 4



1



3



2



4

# Stack Bins

**5. PROFI 1 04951**  
108 × 115 × H75 mm | 40



**6. PROFI 2 04952**  
160 × 115 × H75 mm | 40



**7. PROFI 3 04953**  
209 × 115 × H75 mm | 30



**8. PROFI 4 04954**  
235 × 173 × H125 mm | 20



**9. PROFI 5 04955**  
340 × 200 × H150 mm | 9



**10. PROFI 6 04956**  
440 × 315 × H180 mm | 6



**11. STEP STOOL FOLDABLE 08605**  
486 × 172 × H630 mm | 1



5



6



7



8



9



10



11





# Linear Cabinets

1. BASE CABINET 17206642  
680 x 390 x H900 mm | 1 



2. TALL CABINET 17206640  
680 x 390 x H1730 mm | 1 



1



142 | 8 DIY

2



3



4



# Pro Cabinets

3. TALL CABINET 17210847  
680 x 390 x H1730 mm | 1 



4. BASE CABINET 17210848  
680 x 390 x H900 mm | 1 



143



Create  
amazing  
spaces

## Garden life

Discover the arrangement potential of your garden, terrace or balcony in creating a dream relaxation zone. The key to its creation is in the selection of modern solutions designed with the full comfort of use in mind. The models of chairs, tables, deck chairs and furniture sets we offer respond to current design trends and are made up to meet the highest standards of quality. We invite you to a world full of stylish and practical inspirations that will transform your notion of relaxation opportunities.

Odkryj potencjał aranżacyjny swojego ogrodu, tarasu lub balkonu i stwórz wymarzoną strefę relaksu. Kluczem do jej wykreowania jest wybór nowoczesnych rozwiązań, zaprojektowanych z myślą o pełnej wygodzie użytkowania. Oferowane przez nas modele krzeseł, stołów, leżaków i zestawów meblowych odpowiadają aktualnym trendom wzorniczym i cechują się najwyższą jakością wykonania. Zapraszamy do świata pełnego stylowych i praktycznych inspiracji, które odmienią Twoje wyobrażenia o możliwościach wypoczynku.

Откройте оформительский потенциал своего сада, террасы или балкона и создайте зону отдыха, о которой Вы мечтали. Ключом к ее созданию является выбор современных решений, спроектированных с заботой о полном удобстве пользования. Предлагаемые нами модели стульев, столов, шезлонгов и мебельных комплектов соответствуют актуальным трендам в дизайне и отличаются высочайшим качеством изготовления. Приглашаем Вас в мир, полный стильного и практичного вдохновения, которое изменит Ваше представление о возможностях отдыха.

Fedezze fel a kertjének, teraszának vagy balkonjának berendezésében rejlő lehetőségeket, és hozza létre a pihenésnek azt a zónáját, amire vágyik. Ennek megalkotásához a kulcsot azok a modern megoldások szolgáltatják, amelyeket a használat teljes kényelmére gondolva hoztak létre. Az általunk ajánlott székek, asztalok, nyugágyak és bútor garnitúrák megfelelnek az aktuális trendeknek a formavilágukat illetően, és legmagasabb minőségű kivitelezés jellemző rájuk. Látogasson el a stílusos és praktikus ötletek világába, ami megváltoztatja a pihenési lehetőségekről alkotott elképzeléseit.



**09.  
Chairs**  
p. 146



**10.  
Tables**  
p. 160



**11.  
B&L sets**  
p. 174



**12.  
Sun  
loungers**  
p. 230



KETER®



# 09

## CHAIRS

Krzesta | Стулья | Székek



Create amazing spaces







70% RECYCLED PLASTIC

1

1. MALLORCA 17180335

56 x 58 x 79 cm



2. DANTE LOW BACK 17187058

57 x 57 x 79 cm



3. DANTE HIGH BACK 17187057

57 x 57 x 89 cm



4. SICILIA 17180048

56 x 58 x 79 cm



98% RECYCLED PLASTIC

2



3



4

70% RECYCLED PLASTIC



MIN. 75% RECYCLED PLASTIC

5

# Bali Mono & Bonaire

5. BALI MONO 17190206

55 x 58 x 83 cm



6. BONAIRE 17180277

56 x 57 x 92 cm



6

70% RECYCLED PLASTIC



# SMART Julie

1. JULIE 17209497

61 × 58 × 79 cm



150 | 09 Chairs



ALLIBERT  
by KETER

KETER

2. SAMANNA 17199558

53 × 58 × 83 cm



3. CUBE WITH CUSHION 17192157

42 × 42 × 39 cm



4. TISARA 17199557

53 × 58 × 83 cm



151





1

**1. ELISA 17209499**  
 | 58 × 62 × 79 cm  
 ■ ■

**2. EVA 17210109**  
 | 58 × 62 × 79 cm  
 ■ ■

# Elisa & Eva



3



5



4



**3. ARUBA 17180080**  
 | 61 × 72 × 110 cm  
 ■ ■ ■

**4. SANTORINI 17180012**  
 | 61 × 65 × 99 cm  
 ■ ■ ■

**5. MINNESOTA 17198329**  
 | 61 × 65 × 99 cm  
 ■ ■ ■







1. HARMONY ARMCHAIR 17201284

59 × 60 × 86 cm



2. HARMONY 17201232

47 × 60 × 86 cm



# Harmony LINE



2

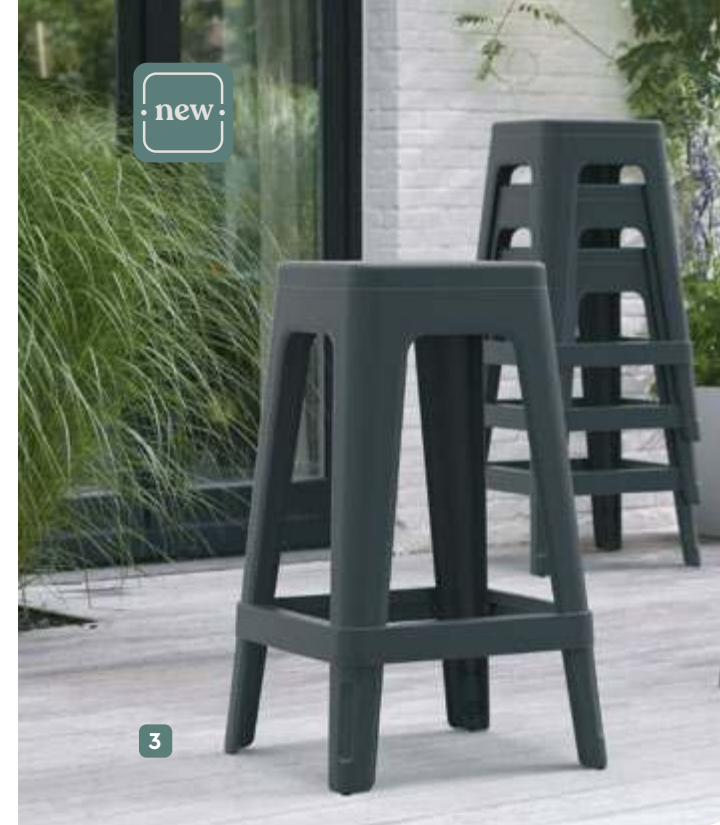

3



5



4



6

3. MISHA BAR STOOL 17212147

38 × 38 × 65 cm



4. AKOLA 17207305

57 × 55 × 80 cm



5. METALIX 17209788

60 × 53 × 81 cm



6. METALINE 17209787

60 × 53 × 81 cm



new

63%  
RECYCLED  
PLASTIC





1



2



1. TRENTON DINING 17202798

63 x 60 x 85 cm



2. VERMONT 17201675

64 x 68 x 107 cm



3. IOWA 17197853

62 x 60 x 89 cm



3







1. ROCKING ADIRONDACK 17211446

92 × 80 × 100 cm



2. TROY ADIRONDACK 17208310

93 × 81 × 97 cm



# Adirondack COMFORT



3. COMFORT ADIRONDACK 17211771

81 × 128 × 102 cm





# 10

## Tables

Stoły | Столы | Asztalok



Create  
amazing  
spaces







1



2

# Melody & Baltimore



4

# Lisa & Elise



3



5

ALLIBERT  
by KETER

KETER

4. QUARTET  
17197992

95 × 95 × 75 cm



5. BALTIMORE 17202808

177 × 100 × 71 cm



1. LISA 17180053

90 × 73 cm



2. ELISE 17180054

137 × 90 × 73 cm



3. MELODY 17190205

161 × 95 × 75 cm







1. GIRONA ROUND WICKER 17204645

160 × 90 × 74 cm



2. GIRONA FLAT WICKER 17205428

160 × 90 × 74 cm



2

# Girona & Lima FAMILY



3

ALLIBERT  
by KETER

KETER

3. LIMA 320 17204320

313 × 98 × 74 cm



4. LIMA 240 17202807

235 × 98 × 74 cm



5. LIMA 160 17202806

157 × 98 × 74 cm



4



5





# Julie SMART TABLE

**2. JULIE**  
17209495 (box) / 17209496 (foil)  
🏠 147 × 90 × 74 cm



180 × 147 × 74 cm



295 × 90 × 74 cm



1 TABLE 2 SETTINGS  
**2 in 1**  
1 TABLE 2 SETTINGS

**2. JULIE DOUBLE TABLE**  
(2 configurations) 17210662  
🏠 2<sup>nd</sup> configuration: 180 × 147 × 74 cm



**3. JULIE DOUBLE TABLE**  
(2 configurations) 17210662  
🏠 1<sup>st</sup> configuration: 295 × 90 × 74 cm







1

1. HARMONY 17201231

160 × 90 × 74 cm



2. HARMONY  
EXTENDABLE 17202278

162-241 × 100 × 74 cm



2

# PERFECT Harmony



3



4

ALLIBERT  
by KETER

KETER

3. FUTURA 17197868

165 × 95 × 75 cm



4. METALEA 17209811

146 × 87 × 75 cm







1

1. LYON TABLE RATTAN 17205429

116 x 71 x 40-65 cm



1 TABLE 2 SETTINGS  
2 in 1  
1 TABLE 2 SETTINGS



2



3



# Luzon FLAT & ROUND

ALLIBERT  
by KETER

KETER

2. LUZON FLAT WICKER 17202176

39 x 39 x 43 cm



3. LUZON ROUND WICKER 17202177

39 x 39 x 43 cm





# UNIVERSAL Orlando



1



2

172 | 10 Tables

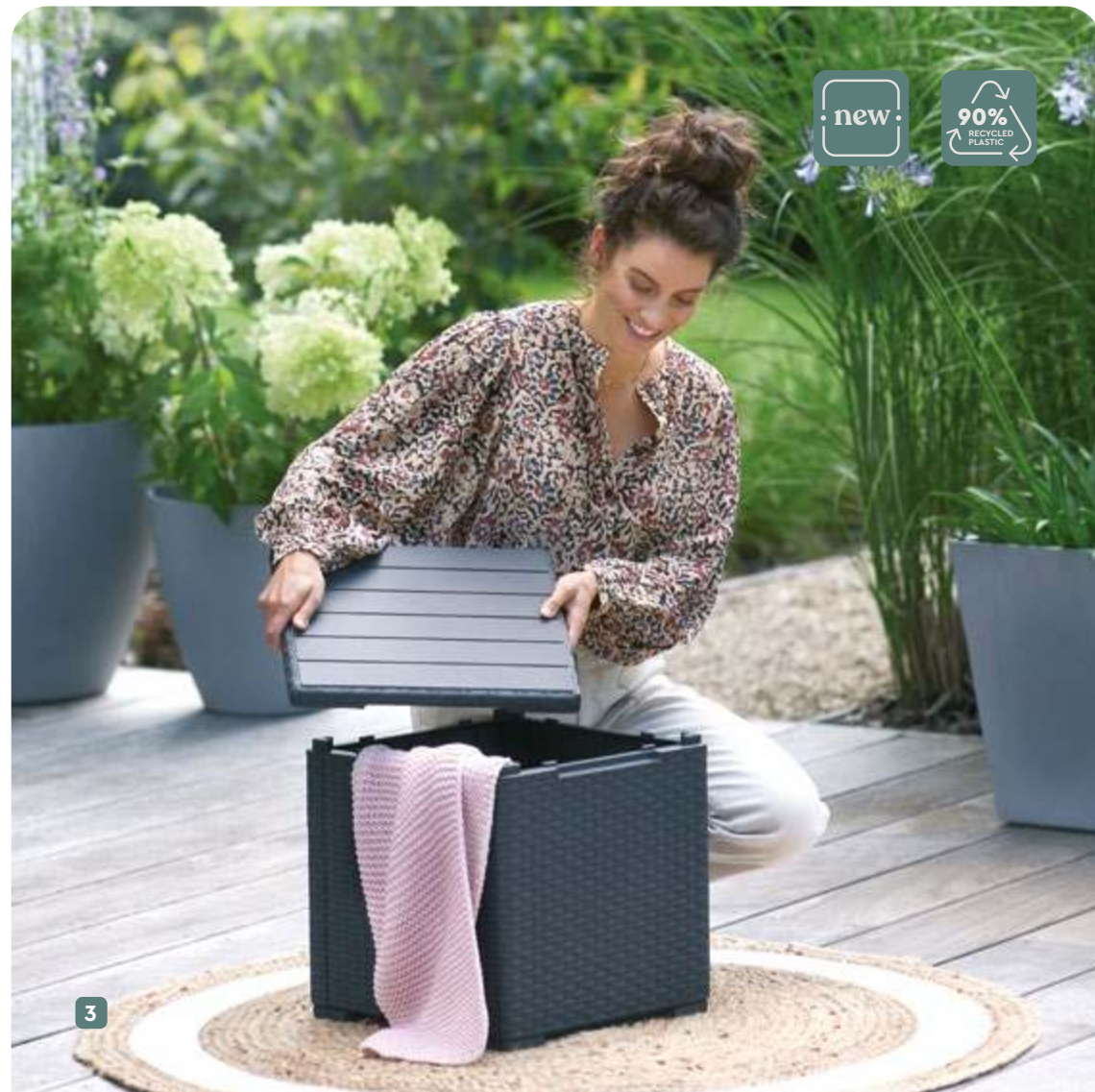

3



4



5

ALLIBERT  
by KETER

KETER

1. ORLANDO SMALL TABLE 17209132

59 x 59 x 43 cm



2. DELUXE SIDE TABLE 17211458

41 x 41 x 52 cm



3. VIGO STORAGE BOX 17212283

37 x 37 x 37 cm



4. ARICA STORAGE TABLE 17200570

79 x 59 x 42 cm



5. LUZON PLUS  
FLAT WICKER 17208454

57 x 57 x 43 cm



173



# 11

## B&L sets

Zestawy meblowe | Наборы мебели | Bútor szettek



Create  
amazing  
spaces







**1. IOWA BALCONY SET 17202175**

chair/krzesło (x2): 62 × 60 × 89 cm  
table/stół: 39 × 39 × 42 cm



**2. TRENTON BALCONY SET 17204380**

chair/krzesło (x2): 63 × 60 × 85 cm  
table/stół: 39 × 39 × 42 cm



# CLEVER BALCONY SETS



ALLIBERT  
by KETER

KETER

**3. RIO PATIO SET 17197637**

chair/krzesło (x2): 77 × 54 × 79 cm  
stool (table)/podnózek (stół): 38 × 38 × 36 cm



**4. ROSARIO BALCONY SET 17200030**

chair/krzesło (x2): 62 × 60 × 89 cm  
table/stół: 59 × 59 × 43 cm



**5. SALVADOR BALCONY SET 17200721**

chair/krzesło (x2): 62 × 60 × 89 cm  
table/stół: 59 × 59 × 43 cm







1

**1. COLUMBIA DINING SET**  
5 PCS 17202279

chair/krzesło (x4): 56 × 54 × 68 cm  
table/stół: 117 × 117 × 75 cm



**2. COLUMBIA DINING SET**  
9 PCS 17204120

chair/krzesło (x4): 56 × 54 × 68 cm  
table/stół: 117 × 117 × 75 cm  
stool/stołek (x4): 52 × 46 × 38 cm



# DINING Columbia Set



2



3



4



5

**3. MONTERO SET 17205049**  
chair/krzesło (x2): 62 × 62 × 89 cm  
bench/ławka: 120 × 62 × 89 cm  
table/stół: 84 × 63 × 45 cm



**4. MONTERO 3 SEATER BENCH**  
17204596

bench/ławka: 150 × 62 × 89 cm



**5. MONTERO 2 SEATER BENCH**  
17204654

bench/ławka: 120 × 62 × 89 cm







1

**1. EMILY BALCONY SET WITHOUT CUSHIONS** 17209815

chair/krzesło (x2): 68 × 64 × 75 cm  
table/stół: 47 × 65 × 42 cm



**2. EMILY BALCONY SET WITH CUSHIONS** 17209814

chair/krzesło (x2): 68 × 64 × 75 cm  
table/stół: 47 × 65 × 42 cm



2

SMART  
**Emily**



3



4



**3. EMILY PATIO SET WITHOUT CUSHIONS** 17209500

chair/krzesło (x2): 68 × 64 × 75 cm  
sofa: 111 × 68 × 75 cm  
table/stół: 65 × 47 × 42 cm



**4. EMILY PATIO SET WITH CUSHIONS** 17209816

chair/krzesło (x2): 68 × 64 × 75 cm  
sofa: 111 × 68 × 75 cm  
table/stół: 65 × 47 × 42 cm







1

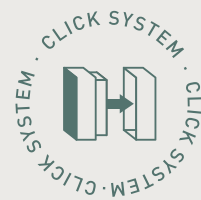

**1. ELODIE 5 SEATER SET WITH STORAGE TABLE 17212057**

1<sup>st</sup> configuration  
 chair/krzesło (x2): 65 × 63 × 74 cm  
 sofa: 65 × 163 × 74 cm  
 table/stół: 55 × 55 × 38 cm



1 set 2 configurations

## Elodie, Rosalie, Claire Lines – 5 seater sets

With this unique design the consumer can choose between 2 configurations before he is going to build up the set. All needed parts are in the 3 seater sofa box to create the version with 2 sofa's and a chair + table.

Dzięki unikalnej konstrukcji klient, zanim zacznie budować zestaw, może wybrać między 2 konfiguracjami. Wszystkie potrzebne części do złożenia mebli w wersji 2 sofy + fotel + stolik znajdują się w kartonie zestawu z 3-osobową sofą.

Уникальный дизайн позволяет пользователю перед началом сборки выбрать один из вариантов итоговой конфигурации. Вместо 3-х местного дивана, можно собрать 2-х местную софу и кресло. Также в комплекте есть стол.

Az egyedi kialakításnak köszönhetően 2 lehetőség közül választhat mielőtt felállítja a szettet. Az összes szükséges alkatrész megtalálható a 3 személyes kanapé dobozában, amelyből készíthetünk két személyes kanapét és fotelt az asztallal együtt.



2 in 1  
 1 SET 2 CONFIGURATIONS | 1 SET 2 CONFIGURATIONS



**2. ELODIE 5 SEATER SET WITH STORAGE TABLE 17212057**

2<sup>nd</sup> configuration  
 chair/krzesło: 65 × 63 × 74 cm  
 sofa (x2): 65 × 113 × 74 cm  
 table/stół: 55 × 55 × 38 cm



2





1

**1. ELODIE 5 SEATER SET WITH CLASSIC TABLE 17209489**

2<sup>nd</sup> configuration

chair/krzesło (x2): 65 × 63 × 74 cm  
sofa: 65 × 163 × 74 cm  
table/stół: 59 × 59 × 43 cm



# LEISURE Elodie



**2. ELODIE 5 SEATER SET WITH CLASSIC TABLE 17209489**

1<sup>st</sup> configuration

chair/krzesło: 65 × 63 × 74 cm  
sofa (x2): 65 × 113 × 74 cm  
table/stół: 59 × 59 × 43 cm



2





1

**1. ELODIE BALCONY SET WITH CLASSIC TABLE 17209482**

chair/krzesło (x2): 65 × 63 × 74 cm  
table/stół: 59 × 59 × 43 cm



**2. ELODIE BALCONY SET WITH STORAGE TABLE 17212108**

chair/krzesło (x2): 65 × 63 × 74 cm  
table/stół: 55 × 55 × 38 cm



2

# LEISURE Elodie



3

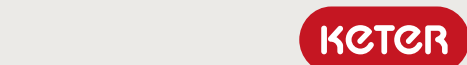

**3. ELODIE 2 SEATER SOFA SET WITH CLASSIC TABLE 17209485**

chair/krzesło (x2): 65 × 63 × 74 cm  
sofa: 65 × 113 × 74 cm  
table/stół: 59 × 59 × 43 cm



**4. ELODIE 2 SEATER SOFA SET WITH STORAGE TABLE 17211877**

chair/krzesło (x2): 65 × 63 × 74 cm  
sofa: 65 × 113 × 74 cm  
table/stół: 55 × 55 × 38 cm



4





1

**1. ELODIE 5 SEATER CORNER WITH CLASSIC TABLE 17210755**  
 corner sofa/narožnik: 172 × 172 × 74 cm  
 table/stól: 59 × 59 × 43 cm



**2. ELODIE 5 SEATER CORNER WITH STORAGE TABLE 17212110**  
 corner sofa/narožnik: 172 × 172 × 74 cm  
 table/stól: 55 × 55 × 38 cm



2



# Elodie CORNER LINE



3



**3. ELODIE 6 SEATER CORNER WITH ORLANDO BIG TABLE 17210757**  
 corner sofa/narožnik: 222 × 172 × 74 cm  
 table/stól: 79 × 59 × 43 cm



**4. ELODIE 6 SEATER CORNER WITH ARICA TABLE 17210758**  
 corner sofa/narožnik: 222 × 172 × 74 cm  
 table/stól: 79 × 59 × 42 cm



4



1. ELODIE DUO 17212571

📏 chair/krzesło (x2): 65 × 63 × 74 cm



2. ELODIE 2 SEATER SOFA 17212572

📏 sofa: 65 × 113 × 74 cm



3. ELODIE 3 SEATER SOFA 17212573

📏 sofa: 65 × 163 × 74 cm



1



# Elodie MIX&MATCH



2



3







**1. ROSALIE BALCONY SET WITH CLASSIC TABLE 17210752**  
 chair/krzesło (x2): 65 × 63 × 74 cm  
 table/stół: 59 × 59 × 43 cm

**2. ROSALIE SET WITH CLASSIC TABLE 17210753**  
 chair/krzesło (x2): 65 × 63 × 74 cm  
 sofa: 65 × 113 × 74 cm  
 table/stół: 59 × 59 × 43 cm



# Rosalie LINE

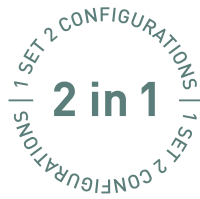

**3. ROSALIE 5 SEATER SET WITH STORAGE TABLE 17212109**  
 chair/krzesło (x2): 65 × 63 × 74 cm  
 sofa: 65 × 163 × 74 cm  
 table/stół: 55 × 55 × 38 cm

**4. ROSALIE 5 SEATER SET WITH ORLANDO BIG TABLE 17210742**  
 chair/krzesło (x2): 65 × 63 × 74 cm  
 sofa: 65 × 163 × 74 cm  
 table/stół: 79 × 59 × 43 cm





# Rosalie CORNER LINE



1

**1. ROSALIE 6 SEATER CORNER WITH ORLANDO BIG TABLE 17210760**  
 corner sofa/narožnik: 222 × 172 × 74 cm  
 table/stól: 79 × 59 × 43 cm

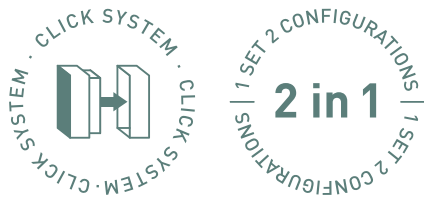

**2. ROSALIE 6 SEATER CORNER WITH ARICA TABLE 17210762**  
 corner sofa/narožnik: 222 × 172 × 74 cm  
 table/stól: 79 × 59 × 42 cm



2





**1. CLAIRE BALCONY WITH ORLANDO SMALL TABLE 17211512**

chair/krzesło (x2): 65 × 63 × 74 cm  
table/stół: 59 × 59 × 43 cm

**2. CLAIRE BALCONY WITH STORAGE TABLE 17211515**

chair/krzesło (x2): 65 × 63 × 74 cm  
table/stół: 55 × 55 × 38 cm



# ELEGANT Claire



2



3

**3. CLAIRE 2 SEATER SOFA SET WITH STORAGE TABLE 17211542**

chair/krzesło (x2): 65 × 63 × 74 cm  
sofa: 65 × 113 × 74 cm  
table/stół: 55 × 55 × 38 cm

**4. CLAIRE 2 SEATER SOFA SET WITH ORLANDO SMALL TABLE 17211519**

chair/krzesło (x2): 65 × 63 × 74 cm  
sofa: 65 × 113 × 74 cm  
table/stół: 59 × 59 × 43 cm



4





1

**1. CLAIRE 5 SEATER SET WITH ORLANDO BIG TABLE 17211543**

chair/krzesło (x2): 65 × 63 × 74 cm  
 sofa: 65 × 163 × 74 cm  
 table/stół: 78 × 59 × 43 cm

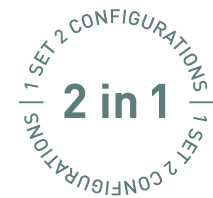

# ELEGANT Claire



**2. CLAIRE 5 SEATER SET WITH STORAGE TABLE 17211545**

chair/krzesło (x2): 65 × 63 × 74 cm  
 sofa: 65 × 163 × 74 cm  
 table/stół: 55 × 55 × 38 cm



2





1

**1. CLAIRE 5 SEAT CORNER WITH ORLANDO SMALL TABLE 17211547**

corner sofa/narožnik: 172 x 172 x 74 cm  
table/stół: 59 x 59 x 43 cm



**2. CLAIRE 5 SEAT CORNER WITH STORAGE TABLE 17211549**

corner sofa/narožnik: 172 x 172 x 74 cm  
table/stół: 55 x 55 x 38 cm



# Claire CORNER LINE



2



3

**3. CLAIRE 6 SEAT CORNER WITH STORAGE TABLE 17211554**

corner sofa/narožnik: 222 x 172 x 74 cm  
table/stół: 55 x 55 x 38 cm



**4. CLAIRE 6 SEAT CORNER WITH ORLANDO BIG TABLE 17211551**

corner sofa/narožnik: 222 x 172 x 74 cm  
table/stół: 78 x 59 x 43 cm



4



# Claire MIX&MATCH



### 3. CLAIRE STORAGE TABLE 17211645

table/stół: 55 × 55 × 38 cm



### 4. CLAIRE 3 SEATER SOFA 17211634

sofa: 65 × 163 × 74 cm



### 1. CLAIRE 2 SEATER SOFA 17211636

sofa: 65 × 113 × 74 cm



### 2. CLAIRE 2 × CHAIR 17211639

chair/krzesło (x2): 65 × 63 × 74 cm







1

**1. CORFU WEEKEND SET 17197786**

chair/krzesło (x2): 75 × 70 × 79 cm  
table/stół: 77 × 57 × 42 cm



**2. CORFU SET 17197361**

chair/krzesło (x2): 75 × 70 × 79 cm  
sofa: 128 × 70 × 79 cm  
table/stół: 77 × 57 × 42 cm



# EPIC Corfu



2



3

**3. CORFU BOX SET 17200180**

chair/krzesło (x2): 75 × 70 × 79 cm  
sofa: 128 × 70 × 79 cm  
table/stół: 79 × 59 × 42 cm



**4. CORFU FIESTA SET 17198008**

chair/krzesło (x2): 75 × 70 × 79 cm  
sofa (x2): 128 × 70 × 79 cm  
table/stół: 161 × 95 × 75 cm



4





**1. CORFU RELAX SET 17202123**  
 corner sofa/narožnik: 190 × 190 × 79 cm  
 table/stół: 77 × 57 × 42 cm



# Corfu MIX&MATCH



**2. CORFU DUO SET 17197993**  
 chair/krzesło (x2): 75 × 70 × 79 cm



**3. CORFU TABLE 17197360**  
 table/stół: 77 × 57 × 42 cm







1

**1. CORFU LOVE SEAT 17197359**

sofa: 128 × 70 × 79 cm



**2. CORFU LOVE SEAT MAX 17197959**

sofa: 182 × 70 × 79 cm



# Corfu MIX&MATCH



2



3

**3. CORFU RELAX SET WITHOUT TABLE 17208435**

corner sofa/narožnik: 190 × 190 × 79 cm



**4. CORFU REST SET WITHOUT TABLE 17208436**

chair/krzesło (x2): 75 × 70 × 79 cm

sofa (x2): 128 × 70 × 79 cm



4





1

**1. BAHAMAS SET 17202269**  
 chair/krzesło (x2): 75 × 70 × 79 cm  
 sofa: 128 × 70 × 79 cm  
 table/stół: 77 × 57 × 42 cm



**2. BAHAMAS FIESTA SET 17205477**  
 chair/krzesło (x2): 75 × 70 × 79 cm  
 sofa (x2): 128 × 70 × 79 cm  
 table/stół: 161 × 95 × 75 cm



2



3

**3. BAHAMAS RELAX SET 17205478**  
 corner sofa/narożnik: 190 × 190 × 79 cm  
 table/stół: 77 × 57 × 42 cm



# SUNNY Bahamas





**1. SALEMO SET 17206003**

chair/krzesło (x2): 74 × 67 × 76 cm  
sofa: 133 × 67 × 76 cm  
table/stół: 76 × 56 × 42 cm



**2. SALEMO BALCONY SET 17205935**

chair/krzesło (x2): 74 × 67 × 76 cm  
table/stół: 76 × 56 × 42 cm



**3. SALEMO 3 SEATER SET 17205990**

chair/krzesło (x2): 74 × 67 × 76 cm  
sofa: 187 × 67 × 76 cm  
table/stół: 76 × 56 × 42 cm



1

# BEAUTIFUL Salemo



2



3



# Salemo

## MIX & MATCH



**1. SALEMO DUO 17209040**

chair/krzesło: (x2): 74 × 67 × 76 cm



**2. SALEMO 2 SEATER SOFA 17209038**

sofa: 133 × 67 × 76 cm



214 | 11 B&L sets



**3. SALEMO TABLE 17209050**

table/stół: 76 × 56 × 42 cm



**4. SALEMO 3 SEATER SOFA 17209039**

sofa: 187 × 67 × 76 cm



215





# JOYFUL Delano



**1. DELANO SET 17201088**  
 chair/krzesło (x2): 65 × 65 × 77 cm  
 bench/ławka: 124 × 65 × 77 cm  
 table/stół: 79 × 54 × 38 cm

**2. DELANO SET WITH LIMA TABLE 160 17205371**  
 chair/krzesło (x2): 65 × 65 × 77 cm  
 bench/ławka (x2): 124 × 65 × 77 cm  
 table/stół: 157 × 98 × 74 cm

**3. TARIFA SET 17197152**  
 chair/krzesło (x2): 71 × 69 × 79 cm  
 sofa: 120 × 69 × 79 cm  
 table/stół: 77 × 55 × 40 cm





**1. PROVENCE SET WITH COFFEE TABLE** 17204454  
 corner sofa/narożnik: 194 × 194 × 77 cm  
 depth/głębokość: 70 cm  
 table/stół: 77 × 57 × 42 cm



**2. PROVENCE ARMCHAIR** 17189413  
 chair/krzesło: 76 × 67 × 77 cm



**3. PROVENCE SET WITHOUT COFFEE TABLE** 17209115  
 corner sofa/narożnik: 194 × 194 × 77 cm  
 depth/głębokość: 70 cm



1



2

# STYLISH Provence



3



4

ALLIBERT  
by KETER

KETER

**4. MIA SET WITH CUSHION BOX** 17198017  
 chair/krzesło (x2): 69 × 70 × 76 cm  
 sofa: 135 × 70 × 78 cm  
 table/stół: 80 × 60 × 42 cm



**5. MONACO SET WITH STORAGE TABLE** 17200031  
 chair/krzesło (x2): 65 × 62 × 77 cm  
 sofa: 129 × 62 × 77 cm  
 table/stół (box table): 79 × 59 × 42 cm



5



**1. ORLANDO 2 SEATER SET  
+ LYON WICKER TABLE 17204944**

chair/krzesło (x2): 65 × 65 × 75 cm  
sofa: 126 × 65 × 75 cm  
table/stół: 116 × 71 × 40-65 cm



**2. ORLANDO SET  
WITH SMALL TABLE 17202809**

chair/krzesło (x2): 65 × 65 × 75 cm  
sofa: 126 × 65 × 75 cm  
table/stół: 59 × 59 × 43 cm



# Orlando LINE



ALLIBERT  
by KETER

KETER







**1. MODENA SET WITH STORAGE TABLE 17200463**

chair/krzesło (x2): 65 × 62 × 77 cm  
sofa: 129 × 62 × 77 cm  
table/stół: 79 × 59 × 42 cm



**2. ALABAMA SET 17199240**

chair/krzesło (x2): 65 × 62 × 77 cm  
sofa: 129 × 62 × 77 cm  
table/stół: 59 × 59 × 43 cm



2

# SUNNY *Modena* & SWEET *Georgia*



3

**3. GEORGIA SET 17199879**

chair/krzesło (x2): 65 × 62 × 77 cm  
sofa: 129 × 62 × 77 cm  
table/stół: 59 × 59 × 43 cm







**1. CALIFORNIA 2 SEATER SOFA**  
17193539

sofa: 141 × 68 × 72 cm



**2. CALIFORNIA 3 SEATER SOFA**  
17196779

sofa: 199 × 68 × 72 cm



**3. CALIFORNIA 2 CHAIRS** 17193538

chair/krzesło (x2): 83 × 68 × 72 cm



**4. CALIFORNIA TABLE** 17194146

table/stół: 68 × 68 × 35 cm







1

**1. CALIFORNIA BAY 3 SEATER SOFA WITH METAL LEGS 17196779**

sofa: 199 × 68 × 72 cm



**2. CALIFORNIA BAY 2 SEATER SOFA WITH METAL LEGS 17193539**

sofa: 141 × 68 × 72 cm



2

# California Bay LINE MIX&MATCH



3

**3. CALIFORNIA BAY 2 CHAIRS WITH METAL LEGS 17193538**

chair/krzesło (x2): 83 × 68 × 72 cm



**4. CALIFORNIA BAY TABLE WITH METAL LEGS 17194146**

table/stół: 68 × 68 × 35 cm



**5. CALIFORNIA BAY HOCKER WITH METAL LEGS 17205964**

table/stół: 68 × 68 × 35 cm



4



5



# COMFORTABLE Moorea



**1. MOOREA TABLE + CHAIR + STOOL WITH CUSHION 17200418**

chair/krzesło: 83 × 68 × 72 cm

table/stół: 68 × 68 × 35 cm

stool/podnózek: 68 × 68 × 40 cm



**2. MOOREA 3 SEATER SOFA 17196779**

sofa: 199 × 68 × 72 cm



1



2



# 12

## Sun loungers

Ležaki | Шезлонги | Nyugágyak



Create  
amazing  
spaces

KETER





1. FLORIDA 17180024

190 x 67 x 30 cm



2. ROMA 17180022

190 x 73 x 37 cm



1



2

# Florida & Roma



3

# STYLISH Jaipur



4

ALLIBERT  
by KETER



3. JAIPUR WITH CUSHION 17207188

187 x 58 x 29 cm



4. JAIPUR 17205843

187 x 58 x 29 cm







1

# Daytona Deluxe



3

## 1. DAYTONA DELUXE 17211632

195 × 65 × 25 cm



## 2. ATLANTIC 17199231

197 × 74 × 36 cm



2



4

# GREAT Pacific

## 3. PACIFIC SET 17201591

sun lounger/leżak (x2): 197 × 75 × 40 cm  
stool (table)/podnózek (stół): 38 × 38 × 36 cm



## 4. PACIFIC 17195066

197 × 75 × 40 cm





Create  
amazing  
spaces

## Garden style

A modern garden is based on a combination of practical and aesthetic solutions. Thanks to them, you can create an orderly space that intrigues with its functionality and allows you to enjoy the beauty of the natural surroundings. Well thought-out form and sophisticated design of garden products: tool sheds, storage containers, wheelbarrows, toys, flowerpots and other accessories enable the fulfilment of many original garden arrangements.

Nowoczesny ogród bazuje na połączeniu praktycznych i zarazem estetycznych rozwiązań. To dzięki nim można stworzyć uporządkowaną przestrzeń, która intryguje swoją funkcjonalnością i pozwala w pełni cieszyć się pięknem naturalnego otoczenia. Przemysłana forma i wyszukane wzornictwo produktów ogrodowych: domków narzędziowych, schowków, taczek, zabawek, doniczek i innych akcesoriów pozwalają na realizację wielu oryginalnych aranżacji ogrodowych.

Современный сад базируется на сочетании практичных и, в то же время, эстетичных решений. Именно благодаря им можно создать упорядоченное пространство, которое интригует своей функциональностью и позволяет полностью наслаждаться красотой природного окружения. Продуманная форма и изысканный дизайн садовой продукции – домиков для инструментов, ящиков, тачек, игрушек, цветочных горшков и других аксессуаров – позволяет реализовать множество вариантов оригинального садового оформления.

A modern kert alapja a praktikus, de ugyanakkor esztétikus megoldások házasítása. Nekik köszönhetően rendezett teret lehet létrehozni, ami felkelti az érdeklődést a funkcionalitásáival, és lehetővé teszi, hogy teljesen élvezhessük a természetes környezet szépségét. Az átgondolt forma és a kerti termékek, szerszámok, tárolók, talicskák, játékok, virágcserepek és más eszközök választékos formavilága lehetővé teszi számos eredeti kertfelrendezés megvalósítását.



**13.  
Garden  
sheds**  
p. 238



**14.  
Storage  
boxes**  
p. 264



**15.  
Carts**  
p. 282



**16.  
Outdoor  
bins**  
p. 286



**17.  
Garden  
toys**  
p. 290



**18.  
Planters**  
p. 294



**19.  
Composters**  
p. 308



**20.  
Garden  
accessories**  
p. 312





# 13

## Garden sheds

Domki narzędziowe | Домики для садовых инструментов | Kerti házak



Create  
amazing  
spaces





# ECONOMIC Manor

1. MANOR 6 x 5 DD 17197128

185 x 152 x 226 cm



2. MANOR PENT 6 x 4 17199514

183 x 111 x 200 cm



3. MANOR 4 x 3 17192190

129 x 103 x 196 cm



1



4



5



6



2



3



7

4. MANOR 6 x 5 DD (TWO WINDOWS AT THE FRONT) 17202483

185 x 152 x 226 cm



5. MANOR PENT 6 x 6 17208243

183 x 185 x 200 cm



6. MANOR 6 x 8 DD 17197129

186 x 237 x 227 cm



7. MANOR 4 x 6 17197126

130 x 192 x 198 cm







1

**1. DARWIN 4 × 6** 17209417

126 × 184 × 205 cm



**2. DARWIN 6 × 4** 17210351

190 × 121 × 221 cm



2

# NATURAL Darwin



3

**3. DARWIN 6 × 6** 17210353

190 × 182 × 221 cm



**4. DARWIN 6 × 8** 17210355

190 × 244 × 221 cm



4





# STABLE Factor



- 1. **FACTOR 6 x 6** 17197898  
 178 x 195 x 208 cm
- 2. **6 FT ACCESSORIES** 17360997  
 164 x 33 x 4 cm
- 3. **FACTOR 8 x 6** 17197897  
 256 x 182 x 243 cm



- 4. **FACTOR 8 x 8** 17197916  
 256 x 255 x 243 cm
- 5. **FACTOR 8 x 11** 17197917  
 256 x 331 x 243 cm



# DECORATIVE Premier



1. PREMIER 757 17210357

🏠 228 × 223 × 252 cm



2. PREMIER 759 17212350

🏠 228 × 287 × 252 cm



3. PREMIER 7511 17212373

🏠 228 × 350 × 252 cm







1. OAKLAND 754 17197419

210 × 125 × 253 cm



2. OAKLAND 757 17201310

229 × 223 × 242 cm



# SHADES OF Oakland



3. OAKLAND 759 17201311

229 × 287 × 242 cm



4. OAKLAND 7511 17201421

229 × 350 × 242 cm





# SHADES OF Oakland



**1. OAKLAND 1175 SD 17204172**  
 Shed 350 × 229 × 254 cm

250 | 13 Garden sheds

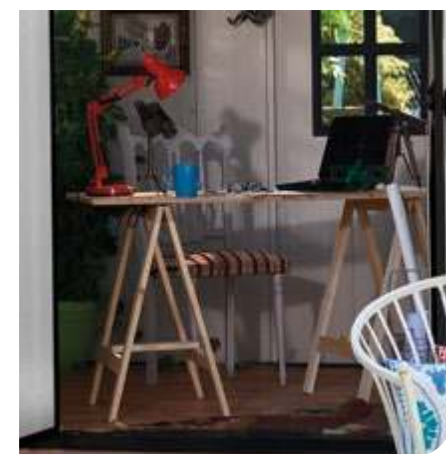

**2. OAKLAND 7513 00252534**

Shed + Ext Kit assembled:  
 230 × 413 × 242 cm  
 (Ext Kit 230 × 126 × 242 cm)

**3. OAKLAND 7515 00252535**

Shed + Ext Kit assembled:  
 230 × 476 × 242 cm  
 (Extension Kit (x2) 230 × 126 × 242 cm)







1



2



3

# CLASSIC Newton

1. NEWTON 757 17208503

🏠 228 × 223 × 252 cm



2. NEWTON 759 17208504

🏠 228 × 287 × 252 cm



3. NEWTON 7511 17208505

🏠 228 × 350 × 252 cm







# CAPACIOUS Cortina

new

1. CORTINA 7 × 7 17206093

🏠 216 × 218 × 226 cm



2. CORTINA 9 × 7 17210836

🏠 279 × 218 × 226 cm



KETER



3. CORTINA MEGA 2020 L 17212413

🏠 191 × 109 × 133 cm



4. CORTINA BELLA 1000 L 17212478

🏠 140 × 74 × 120 cm



5. CORTINA ALTO 1400 L 17212412

🏠 140 × 74 × 170 cm





# RELIABLE Artisan



1. ARTISAN 7 × 7 17203426

🏠 214 × 218 × 226 cm



2. ARTISAN 9 × 7 17204256

🏠 277 × 218 × 226 cm



3. ARTISAN 11 × 7 17208122

🏠 342 × 218 × 226 cm







1

# FINEST Storage



1. PATIO STORE 17204254

🏠 140 × 74 × 120 cm



2. HIGH STORE PLUS 17209457

🏠 140 × 74 × 170 cm



2



3

3. GRANDE STORE 17212383

🏠 190 × 109 × 132 cm



4. ELITE STORE 1150 L 17206448

🏠 141 × 82 × 123 cm



4



# Premier LINE



1. PREMIER TALL 17209552  
140 × 74 × 170 cm



2. PREMIER XL 17207331

141 × 82 × 123 cm



3. PREMIER JUMBO 17212384

191 × 109 × 133 cm





# Store It Out LINE

### 1. NEW STORE IT OUT MIDI UPGRADED 17210426

132 × 71 × 113 cm



### 2. STORE IT OUT MAX 17199416

145 × 82 × 125 cm



### 3. STORE IT OUT MIDI PRIME UPGRADED 17210430

132 × 71 × 113 cm



1



4



2



3



5



### 4. STORE IT OUT ULTRA 17199414

177 × 113 × 134 cm



### 5. STORE IT OUT ARC 17199415

146 × 82 × 120 cm





# 14

## Storage boxes

Skrzynie do przechowywania | Ящики для хранения | Tároló dobozok



Create  
amazing  
spaces







1

**1. SHERWOOD STORAGE BOX**  
270 L 17198596  
117 × 45 × 58 cm



**2. HOLLYWOOD STORAGE BOX**  
270 L 17191974  
117 × 45 × 57 cm



**3. SAMOA RATTAN BOX 270 L 17209570**  
117 × 45 × 57 cm



2



3



## RELIABLE Samoa



4



**4. MARVEL PLUS STORAGE BOX**  
270 L 17202622

117 × 45 × 57 cm



**5. COMFY STORAGE BOX 270 L 17202623**

117 × 45 × 57 cm



**6. CAPRI STORAGE BOX 305 L 17201486**

123 × 53 × 57 cm



5



6





# SPACIOUS Storage Boxes



96%  
RECYCLED  
PLASTIC

1

**1. CITY STORAGE BOX 113 L 17208324**

58 × 44 × 55 cm



**2. URBAN STORAGE BOX 113 L 17208013**

60 × 46 × 53 cm



80%  
RECYCLED  
PLASTIC

2



70%  
RECYCLED  
PLASTIC

3

**3. SPRINGWOOD STORAGE BOX 305 L 17202378**

123 × 53 × 57 cm



**4. EMILY STORAGE BOX 280 L 17210608**

118 × 44 × 58 cm



4



**1. KENTWOOD STORAGE BOX**

350 L 17210604

128 × 54 × 59 cm



**2. ROCKWOOD STORAGE BOX**

570 L 17197729

155 × 72 × 64 cm



**3. NOVEL STORAGE BOX**

340 L 17197948

124 × 55 × 62 cm

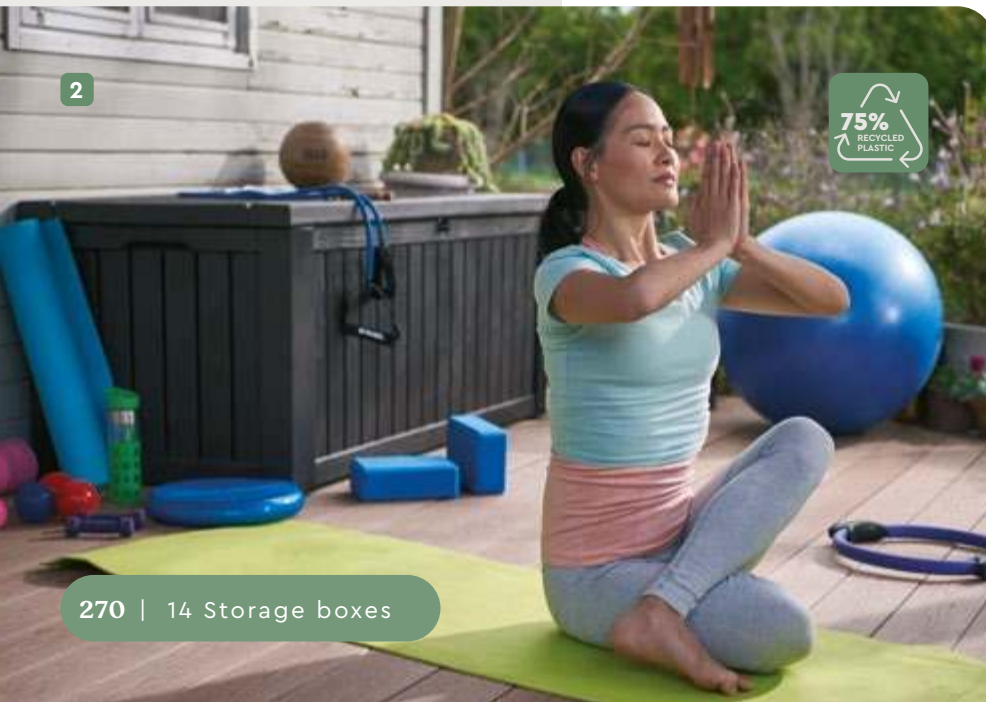

**4. EDEN GARDEN BENCH 265 L 17190198**

140 × 60 × 84 cm



**5. HUDSON STORAGE BENCH**

227 L 17204490

133 × 61 × 89 cm



**6. PATIO STORAGE BENCH**

227 L 17202690

133 × 61 × 89 cm





# ROOMY Storage Boxes

- 1. BORNEO STORAGE BOX**  
416 L 17197731  
130 x 70 x 63 cm  
[Color swatches]
- 2. BRUSHWOOD STORAGE BOX**  
454 L 17202631  
145 x 70 x 60 cm  
[Color swatches]
- 3. POOL STORAGE BOX 511 L 17205835**  
145 x 73 x 64 cm  
[Color swatches]



- 4. GLENWOOD STORAGE BOX**  
390 L 17193522  
128 x 65 x 61 cm  
[Color swatches]
- 5. BRIGHTWOOD STORAGE BOX**  
454 L 17194454  
145 x 70 x 60 cm  
[Color swatches]





1. DARWIN BOX 380 L 17211691

143 × 65 × 55 cm



# Darwin BOXES



2. DARWIN BOX 570 L 17211696

143 × 65 × 78 cm



3. DARWIN BOX 662 L 17212311

143 × 65 × 90 cm



2

EXTRA SEATING

PISTONS FOR EASY OPENING

ALL WEATHER RESISTANCE

LOCKABLE

SIDE HANDLES

WOOD LOOK & FEEL

3





# Safe STORAGE



# Parcel box



3. JAVA STORAGE BOX 870 L 17204486

147 × 83 × 86 cm



4. PARCEL BOX 17209502

53 × 62 × 112 cm



1. NORTHWOOD STORAGE BOX  
630 L 17210056

155 × 72 × 69 cm



2. ONTARIO STORAGE BOX  
870 L 17204488

147 × 83 × 86 cm







1

1. DENALI DECK BOX 270 L 17205660

152 × 62 × 54 cm



2. DENALI DECK BOX 380 L 17205969

152 × 62 × 71 cm



2

# AMAZING Denali



3

3. DENALI DECK BOX 757 L 17207423

152 × 72 × 90 cm



4. DENALI DECK BOX 570 L 17205943

152 × 72 × 70 cm



4





1

# GRILL TIME Unity



2



3



1. UNITY 105 L 17202663

82 × 52 × 90 cm



2. UNITY XL 207 L 17202662

134 × 52 × 90 cm



3. UNITY CHEF 415 L 17206370

237 × 52 × 90 cm





# 15

## Carts

Taczki | Тачки | Talicskák



Create amazing spaces





**1. REALBARROW 100 L**

17186746

127 × 57 × 60 cm



**2. EASY GO BREEZE 50 L**

17199467

51 × 56 × 84 cm



**3. EASY GO 55 L**

17182462

53 × 58 × 89 cm



**4. EASY GO XL 62 L**

17190643

51 × 60 × 89 cm



1



2

# USEFUL Carts



3



4





# 16

## Outdoor bins

Kosze zewnętrzne | Уличные контейнеры | Külső szemetesek



Create  
amazing  
spaces





# USEFULL Refuse



## 1. REFUSE CONTAINER 90 L

17187521 (02974)

♻️ 49 × 58 cm



## 2. REFUSE BIN 110 L 17183336 (12900)

♻️ 56 × 52 × 88 cm



## 3. REFUSE BIN 110 L 17183336 (12900)

♻️ 56 × 52 × 88 cm



# Baltimore & Rockford BINS

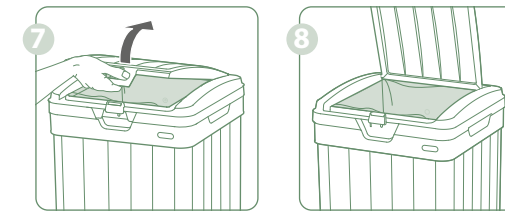
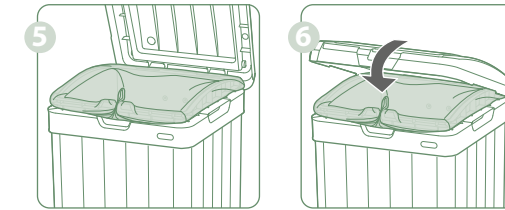
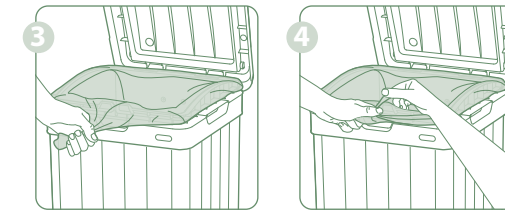
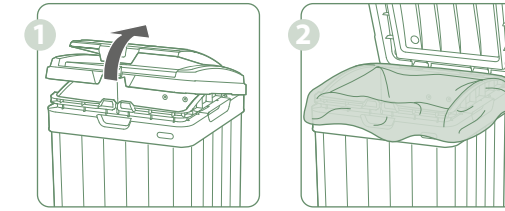

## 4. BALTIMORE REFUSE BIN 125 L 17206192

♻️ 41 × 41 × 87 cm



## 5. ROCKFORD REFUSE BIN 125 L 17205944

♻️ 41 × 41 × 87 cm





# 17

## Garden toys

Zabawki ogrodowe | Садовые игрушки | Keri játékok



Create  
amazing  
spaces



KETER



1. CREATIVE FUN TABLE

17184058

79 x 56 x 50 cm



# Creative FUN



2. KIDS CHAIR 17185444

43 x 39 x 53 cm



3. KIDS TABLE 17185443

64 x 64 x 48 cm





# 18

## Planters

Doniczki | Цветочные горшки | Virágcserepek



Create  
amazing  
spaces

KETER







# INSPIRED BY Rattan



**1. RATTAN PLANTER M 55.4 L 17192301**

☞ 38 × 38 × 57 cm



**2. RATTAN PLANTER S 23.6 L 17192300**

☞ 28 × 28 × 43 cm



**3. CONIC PLANTER 56.5 L 17202754**

☞ ø54 × 49 cm



2



3



4



5



6

7

## Cozy ELEGANCE



**4. COZIES TRIO 1.7 L 17202587**

☞ ø15 × 11 cm



**5. COZY L 22.8 L 17202258**

☞ ø54 × 20 cm



**6. COZY S WITH HANGING CHAIN 3.2 L 17201493**

☞ ø28 × 18 cm



**7. COZY M WITH HANGING CHAIN 9.4 L 17202379**

☞ ø36 × 22 cm







**1. CYLINDER PLANTER S 7 L 17197833**

☕ 28 × 28 cm



**2. CYLINDER PLANTERS SET S + M + L 17197934**

☕ 28 × 28 cm | 36 × 37 cm | 44 × 44 cm



**3. CYLINDER PLANTER L 39 L 17197837**

☕ 44 × 44 cm



**4. CYLINDER PLANTER M 18 L 17197835**

☕ 36 × 37 cm



# AMAZING Cylinder Planters



# GREEN Cube

**5. CUBE PLANTER S 21.5 L 17202066**

☕ 29 × 29 × 30 cm



**6. CUBE PLANTER M 50.5 L 17201220**

☕ 39 × 39 × 39 cm



**7. HANGING SPHERE PLANTER 8.6 L 17199246**

☕ 35 × 22 cm





1



300 | 18 Planters



2

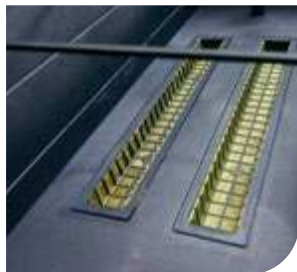

# SMART Plants GROWING



3

**1. ALFRESCO GARDEN BED 110 L** 17209689

📏 112 × 46 × 84 cm



**2. URBAN BLOOMER 48 L** 17202940

📏 82 × 37 × 78 cm



**3. DARWIN ELEVATED GARDEN BED PRO 48 L** 17211713

📏 113 × 48 × 80 cm





# NICE Plants GROWING



**1. FULL BLOOM 120 L  
ROUND WEAVES 17210614**

📏 114 x 49 x 76 cm



**2. EASY GROW 120 L  
RATTAN WEAVES 17194592**

📏 114 x 49 x 76 cm



**3. SPLENDOR 120 L 17211629**

📏 114 x 49 x 76 cm



1



2



3





1. SEQUOIA DUOTECH M 88 L 17206727  
 99 × 58 × 50 cm



# Maple LINE



2



3



2. MAPLE MOBILE URBAN GARDEN BED 88 L 17210887

99 × 58 × 65 cm



3. MAPLE GREEN HOUSE 88 L 17209667

99 × 58 × 185 cm





# Maple LINE & Vista Modular



1. MAPLE SQUARE 333 L 17209665

106 x 106 x 32 cm



2. MAPLE TROUGH 150 L 17209666

106 x 50 x 32 cm



306 | 18 Planters



3. VISTA MODULAR GARDEN BED 2 PACK 718 L 17210708

(x2) 122 x 122 x 27 cm



4. VISTA MODULAR GARDEN BED 359 L 17210619

122 x 122 x 27 cm

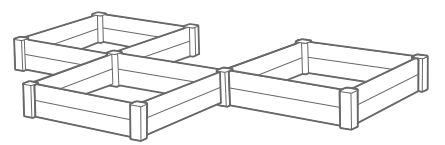
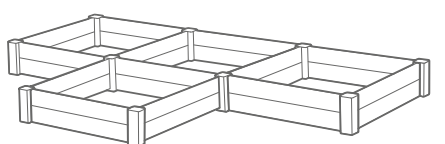
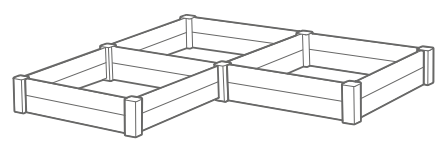

307



# 19

## Composters

Kompostowniki | Компостеры | Komposztálók



Create  
amazing  
spaces





# Handy COMPOSTER



**1. DECO COMPOSTER WITH BASE 340 L 17196661**

72 × 69 × 74 cm



**2. E-COMPOSTER WITHOUT BASE 470 L 17186236**

79 × 79 × 79 cm



**3. E-COMPOSTER WITH BASE 470 L 17186362**

79 × 79 × 79 cm



1



4



**4. MEGA COMPOSTER 650 L 17184214**

87 × 87 × 107 cm



**5. ECO COMPOSTER 320 L 17181157**

65 × 65 × 75 cm



2



3



5



# 20

## Garden accessories

Aksesoria ogrodowe | Садовые аксессуары | Kerti tartozékok



Create  
amazing  
spaces

KETER





# Go Bar



1. GO BAR 17209508  
 ø38 × 37-60 cm



# DESIGNER Cool Bar



2



3

2. COOL BAR 17186745  
 ø49 × 57-84 cm



3. ILLUMINATED COOL BAR 17204184  
 ø49 × 57-84 cm







96% RECYCLED PLASTIC

1

1. COOL STOOL 17200045

∅44 × 44 cm



2. BEVY BAR 17209510

83 × 40 × 52-75 cm



# Cool Bar LINE



60% RECYCLED PLASTIC

2



3



60% RECYCLED PLASTIC

3. COOL BAR RATTAN 17194548

∅49 × 57-82 cm



4. ICE CUBE 17194600

42 × 42 × 41 cm



4



65% RECYCLED PLASTIC



# GREAT new Patio Cooler

1. PATIO COOLER & BEVERAGE CART 17210407

96 × 58 × 90 cm (closed)



2. RAILING SHELF 17211832

80 × 45 × 33 cm



3. CORNER TOOL RACK 17361063

56 × 56 × 95 cm



1



2



3



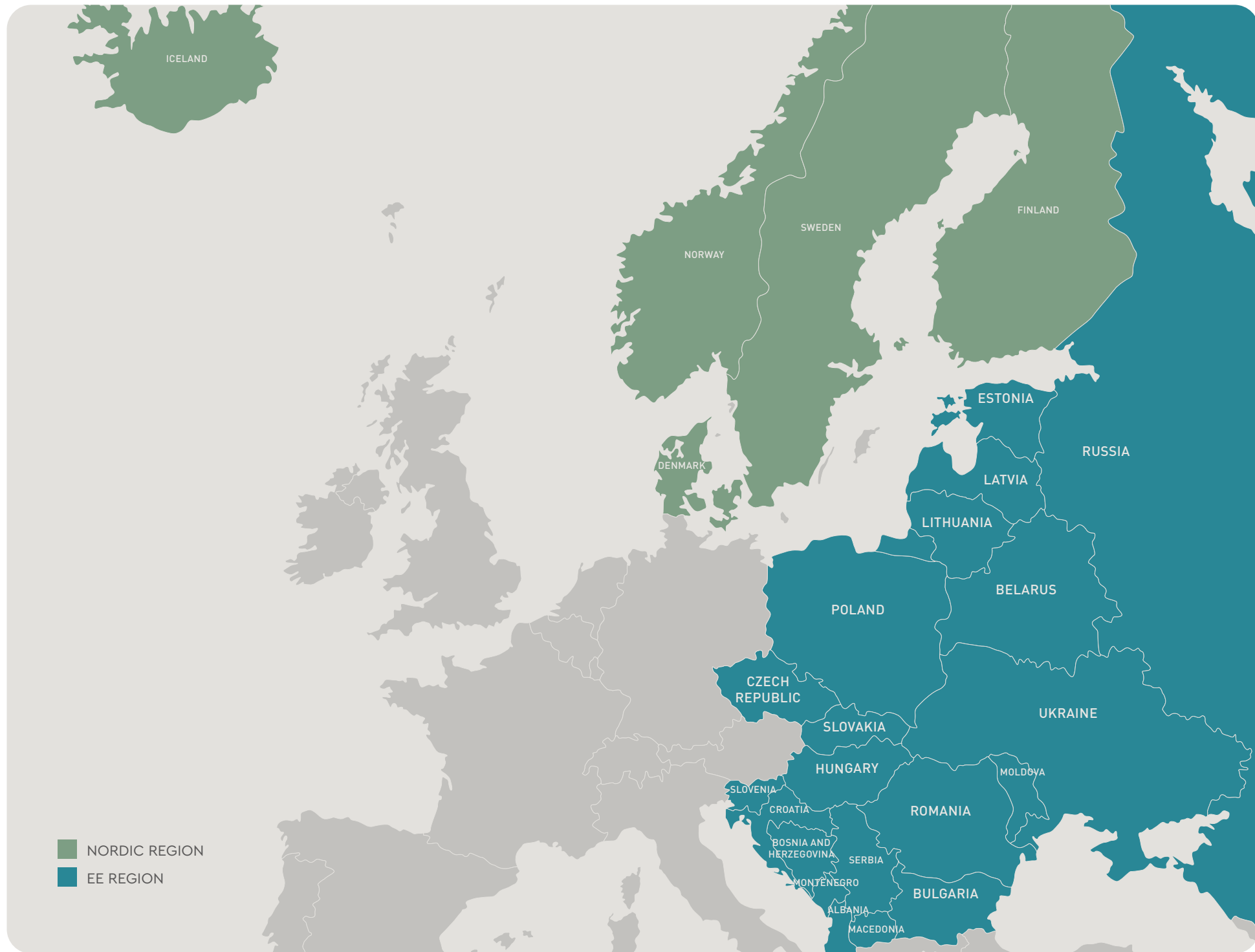

Create amazing spaces



Welcome home



Products, dimensions, colours and other information are subject to change. No rights may be derived from the information in this catalogue. Produkty, ich wymiary, kolorystyka oraz inne informacje mogą ulec zmianie. Katalog pełni jedynie funkcję informacyjną i nie stanowi oferty handlowej w rozumieniu kodeksu cywilnego. Продукты, их размеры, цвета, а также другие данные могут быть изменены. Каталог носит исключительно информационный характер и не является публичной офертой, определяемой положениями Гражданского кодекса. A termék, azok méretei, színei, valamint más információk változhatnak. A katalógusban szereplő információ kizárólag tájékoztató jellegű, nem tekinthető a polgári törvénykönyv értelmében vett kereskedelmi ajánlatnak.

# We design with people in mind.



## Keter Poland Sp. z o.o.

Batory Office Building  
Al. Jerozolimskie 212A  
02-486 Warszawa  
Poland

ul. Wrocławska 34  
76-200 Słupsk  
Poland  
Phone: +48 59 841 12 30  
Fax: +48 59 842 42 14  
E-mail: slupsk.poland@keter.com

[www.curver.com](http://www.curver.com)

[www.curver.pl](http://www.curver.pl)

[www.keter.pl](http://www.keter.pl)

[www.curver.hu](http://www.curver.hu)

## Keter Hungary Kft.

Zsong-völgy 2  
4211 Ebes  
Hungary  
Phone: +36 52 565 900  
Fax: +36 52 565 990

E-mail: info.hungary@keter.com

[www.keter-lifestyle.com](http://www.keter-lifestyle.com)

[www.keter-lifestyle.pl](http://www.keter-lifestyle.pl)

[www.keter-lifestyle.com/ru](http://www.keter-lifestyle.com/ru)

[www.keter-lifestyle.com/hu](http://www.keter-lifestyle.com/hu)

[www.keter-lifestyle.com/ro](http://www.keter-lifestyle.com/ro)

[www.keter-lifestyle.com/rs](http://www.keter-lifestyle.com/rs)

[www.keter-lifestyle.com/ua](http://www.keter-lifestyle.com/ua)

[www.keter-lifestyle.com/al](http://www.keter-lifestyle.com/al)

[www.keter-lifestyle.com/lt](http://www.keter-lifestyle.com/lt)





**CURVER**



[www.curver.com](http://www.curver.com)

**KETER**

**ALLIBERT**  
by **KETER**

[www.keter.com](http://www.keter.com)

[www.keter-lifestyle.com](http://www.keter-lifestyle.com)